



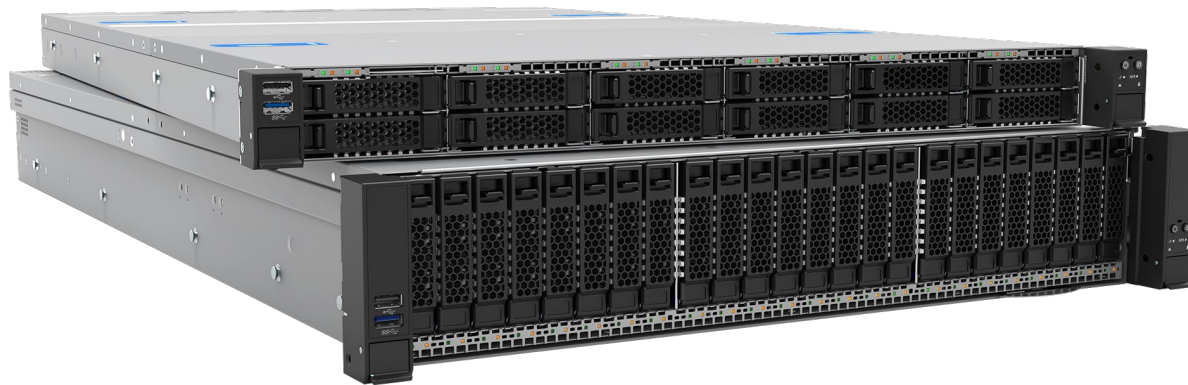
# Intel® Server M50CYP Family

## *Configuration Guide*

A reference document to identify available Intel® Server building blocks, integrated systems, accessories, and spare parts associated with the Intel® Server M50CYP product family.

Rev. 1.7

January 2022



# M50CYP

Delivering Breakthrough Data Center System Innovation – Experience What's Inside!

<This page is intentionally left blank>

## Document Revision History

| Date           | Revision | Changes  |
|----------------|----------|--|
| May 2021       | 1.0      | Initial production release.  |
| May 2021       | 1.1      | <ul style="list-style-type: none"> <li>• Tables 10, 11, 12, and 13. Updated packaged gross wt and un-packaged net wt</li> <li>• Table 18. Updated Description column for iPC CYPCBLSL204KIT</li> <li>• Chapter 6. Updated 2U GPGPU air duct image</li> <li>• Chapter 7. Updated 2U Tall air duct and 2U Tall air duct images</li> <li>• Tables 37 and 38. Updated tables.</li> <li>• Minor updates throughout for clarity</li> </ul>   |
| June 2021      | 1.2      | <ul style="list-style-type: none"> <li>• Tables 10, 11, 12, 13. Updated "Optional Accessories (sold separately)" column</li> <li>• Table 26. Updated 5<sup>th</sup> column</li> <li>• Table 35. Updated 1600 W and 2100 W PSUs</li> <li>• Minor updates throughout for clarity</li> </ul>  |
| June 2021      | 1.3      | <ul style="list-style-type: none"> <li>• Table 4, 5, 6. Updated tables</li> <li>• Table 20. Updated 4<sup>th</sup> column</li> </ul>   |
| July 2021      | 1.4      | <ul style="list-style-type: none"> <li>• Tables 2, 3, 4, 5, 6. Updated tables</li> <li>• Section 1.1.1. Updated section to move M SKU from Supported to Not Supported SKU.</li> <li>• Section 1.1.3. Updated 8<sup>th</sup> bullet.</li> <li>• Tables 10 and 11. For the "Included" column, updated heat sink reference number from "iPN" to "IPC".</li> <li>• Figures 20 and 21. Updated figures.</li> <li>• Removed "Intel® Integrated RAID Module RMSP3 Product Family" section</li> <li>• Tables 18, 19, 20, 21, 22, 24, 25, 26. Updated tables</li> </ul> |
| August 2021    | 1.5      | <ul style="list-style-type: none"> <li>• Table 18. Added row on iPC CYPCBLSLHDKIT</li> <li>• Tables 19, 20, 21, 22, 24. Updated tables.</li> <li>• Section 5.3.1, "Intel® Integrated RAID Module RMSP3 Product Family". Added section</li> </ul>   |
| September 2021 | 1.6      | <ul style="list-style-type: none"> <li>• Table 18. Added the cable kits in the last four rows</li> <li>• Table 19. Updated second and third columns.</li> <li>• Table 38. Updated Description column for 1U EVAC Heat Sink</li> <li>• Table 39. Updated Description column for 2U Tall Air Duct row</li> </ul>   |
| January 2022   | 1.7      | <ul style="list-style-type: none"> <li>• Table 18. Added CYPCBLSLHDKIT cable kit</li> <li>• Table 18. Corrected MM# for CYPASMODINT</li> <li>• Table 18. Corrected image and description for CYPCBLSLSSRIS</li> <li>• Table 29. Added E810CQDA1OCPV3, E810XXVDA4OCPV3, X710DA2OCPV3 and X710T4LOCPV3 cards</li> <li>• Table 30 and 31. Updated Description for all Storage and RAID controllers.</li> <li>• Corrected Details and Description for CYPCBLINTSTKIT</li> </ul>  |

## ***Disclaimers***

Intel technologies' features and benefits depend on system configuration and may require enabled hardware, software, or service activation. Performance varies depending on system configuration. No computer system can be absolutely secure. Check with your system manufacturer or retailer or learn more at [intel.com](http://intel.com).

You may not use or facilitate the use of this document in connection with any infringement or other legal analysis concerning Intel products described herein. You agree to grant Intel a non-exclusive, royalty-free license to any patent claim thereafter drafted which includes subject matter disclosed herein.

No license (express or implied, by estoppel or otherwise) to any intellectual property rights is granted by this document.

The products described may contain design defects or errors known as errata which may cause the product to deviate from published specifications. Current characterized errata are available on request.

Intel disclaims all express and implied warranties, including without limitation, the implied warranties of merchantability, fitness for a particular purpose, and non-infringement, as well as any warranty arising from course of performance, course of dealing, or usage in trade.

This document contains information on products, services and/or processes in development. All information provided here is subject to change without notice. Contact your Intel representative to obtain the latest Intel product specifications.

Copies of documents which have an order number and are referenced in this document may be obtained by calling 1-800-548-4725 or by visiting [www.intel.com/design/literature.htm](http://www.intel.com/design/literature.htm).

Intel, Intel Optane, Xeon, and the Intel logo are trademarks of Intel Corporation or its subsidiaries in the U.S. and/or other countries.

\*Other names and brands may be claimed as the property of others.

© Intel Corporation

# Table of Contents

|  |           |
|--|-----------|
| <b>1. Intel® Server M50CYP Family Overview .....</b>                                     | <b>11</b> |
| 1.1 Configuration Overview.....  | 11        |
| 1.1.1 Processor Support.....   | 12        |
| 1.1.2 Memory Support .....   | 14        |
| 1.1.3 System Configuration Notes.....  | 14        |
| 1.2 Reference Documents and Support Collaterals.....                                     | 17        |
| 1.3 Intel® Server Board M50CYP2SB Family .....   | 19        |
| 1.4 Intel® Server System M50CYP1UR Family.....   | 25        |
| 1.5 Intel® Server System M50CYP2UR Family.....   | 31        |
| 1.6 Available Server Board, Chassis, and System SKU Summary.....                         | 38        |
| <b>2. Server Board Options .....</b>   | <b>39</b> |
| 2.1 Intel® Server Board M50CYP2SB Family Options.....                                    | 40        |
| <b>3. Server System Configurations .....</b>   | <b>42</b> |
| 3.1 Intel® Server System M50CYP1UR Family – (1U Rack Mount System).....                  | 43        |
| 3.2 Intel® Server System M50CYP2UR Family – (2U Rack Mount System).....                  | 46        |
| <b>4. SAS / SATA / NVMe* Data Cable Guide .....</b>                                      | <b>49</b> |
| 4.1 Data Cable Connector Types.....  | 51        |
| 4.2 1U / 2U Server System SAS / SATA / NVMe* Cable Kits.....                             | 52        |
| 4.2.1 Cable Kit Product Code Decoder Examples.....                                       | 53        |
| 4.2.2 Cable Kit Order Information .....  | 54        |
| 4.2.3 Cable Recommendations.....   | 60        |
| 4.3 1U 4 x 2.5" – M50CYP1UR204 SAS /SATA / NVMe* Data Cable Guide.....                   | 61        |
| 4.4 1U 12 x 2.5" – M50CYP1UR212 SAS / SATA / NVMe* Data Cable Guide.....                 | 63        |
| 4.5 2U 2.5" Front Mount Drive Bay Cable Guide.....                                       | 65        |
| 4.5.1 M50CYP2UR208 SAS / SATA / NVMe* Data Cable Guide for up to 8 Front Drive Bays..... | 65        |
| 4.5.2 M50CYP2UR 16 x 2.5" SAS / SATA / NVMe* Data Cable Guide.....                       | 68        |
| 4.5.3 M50CYP2UR 24 x 2.5" SAS / SATA / NVMe* Data Cable Guide.....                       | 72        |
| 4.6 2U 12 x 3.5" – M50CYP2UR312 SAS / SATA / NVMe* Data Cable Guide.....                 | 76        |
| <b>5. 1U / 2U System Optional Accessories .....</b>                                      | <b>78</b> |

|                    |   |            |
|--------------------|---|------------|
| 5.1                | 1U / 2U PCIe* Riser Card Accessory / Spare FRU Options..... | 78         |
| 5.1.1              | 1U Riser Card Options.....                                  | 78         |
| 5.1.2              | 2U Riser Card Options.....                                  | 80         |
| 5.2                | Intel® Ethernet Network Adapters for OCP* .....             | 83         |
| 5.3                | Intel® RAID Add-In Cards, Modules, and Accessories .....    | 87         |
| 5.3.1              | Intel® Integrated RAID Module RMSP3 Product Family .....    | 87         |
| 5.3.2              | Intel® RAID Controller Add-in Cards.....                    | 88         |
| 5.3.3              | Intel® VROC Keys .....                                      | 90         |
| 5.3.4              | Miscellaneous Intel® RAID Accessory Options.....            | 93         |
| 5.4                | Power Supply Unit Options and Power Cable Kits .....        | 94         |
| 5.5                | 1U / 2U Rack Mount Kits .....                               | 97         |
| <b>6.</b>          | <b>1U / 2U Miscellaneous Accessory Options.....</b>         | <b>99</b>  |
| <b>7.</b>          | <b>1U / 2U Spare and Replacement Parts (FRUs) .....</b>     | <b>103</b> |
| <b>Appendix A.</b> | <b>Glossary .....</b>                                       | <b>107</b> |

## List of Figures

|  |    |
|--|----|
| Figure 1. Intel® Server M50CYP Family Overview.....                                | 11 |
| Figure 2. 3 <sup>rd</sup> Gen Intel® Xeon® Scalable Processor Identification.....  | 12 |
| Figure 3. Intel® Server Board M50CYP2SB1U Component / Feature Identification ..... | 19 |
| Figure 4. Intel® Server Board M50CYP2SBSTD Component / Feature Identification..... | 20 |
| Figure 5. Server System Components Overview.....                                   | 25 |
| Figure 6. 4 x 2.5" front Drive Bay Configuration – M50CYP1UR204.....               | 26 |
| Figure 7. 12 x 2.5" front Drive Bay Configuration – M50CYP1UR212 .....             | 26 |
| Figure 8. Back Panel Feature Identification.....                                   | 26 |
| Figure 9. Intel® Server System M50CYP2UR Feature Set Identification.....           | 31 |
| Figure 10. 2U 8 x 2.5" Front Drive Bay Configuration – M50CYP2UR208 .....          | 32 |
| Figure 11. 2U 16 x 2.5" Front Drive Bay Configuration (based on M50CYP2UR208)..... | 32 |
| Figure 12. 2U 24 x 2.5" Front Drive Bay Configuration (based on M50CYP2UR208)..... | 32 |
| Figure 13. 2U 12 x 3.5" Front Drive Bay Configuration – M50CYP2UR312 .....         | 33 |
| Figure 14. 2U Back Panel Feature Identification.....                               | 33 |
| Figure 15. Illustration of Building Block Options.....                             | 39 |
| Figure 16. Intel® Server System M50CYP1UR Family Options.....                      | 42 |
| Figure 17. Intel® Server System M50CYP2UR Family Options.....                      | 42 |
| Figure 18. 2U 8 x 2.5" SAS / SATA / NVMe* Hot-Swap Backplane – Back Side .....     | 49 |
| Figure 19. 2U 12 x 3.5" HSBP Connector Identification – Back Side .....            | 50 |
| Figure 20. 1U 4 x 2.5" SAS / SATA / NVMe* Hot Swap Backplane – Back Side .....     | 50 |
| Figure 21. 1U 12 x 2.5" SAS / SATA / NVMe* Hot Swap Backplane – Back Side .....    | 50 |
| Figure 22. 4 x 2.5" Front Drive Bay Configuration – M50CYP1UR204.....              | 61 |
| Figure 23. 12 x 2.5" Front Drive Bay Configuration – M50CYP1UR212 .....            | 63 |
| Figure 24. 2U 8 x 2.5" Front Drive Bay Configuration – M50CYP2UR208 .....          | 65 |
| Figure 25. 2U 16 x 2.5" Front Drive Bay Configuration.....                         | 68 |
| Figure 26. SAS Expander RES3TV360 Port Mapping.....                                | 71 |
| Figure 27. 2U 24 x 2.5" M50CYP2UR208 Front Drive Bay Configuration.....            | 72 |
| Figure 28. 2U 2.5" x 24 System HSBP Enumeration.....                               | 73 |
| Figure 29. 2U 12 x 3.5" M50CYP2UR312 Front Drive Bay Configuration.....            | 76 |

Figure 30. Intel® Ethernet Network Adapter Placement ..... 83

Figure 31. OCP\* Module Bay Filler Removal (2U System Shown) ..... 84

Figure 32. OCP\* Module with Pull tab Installation (2U System Shown) ..... 84



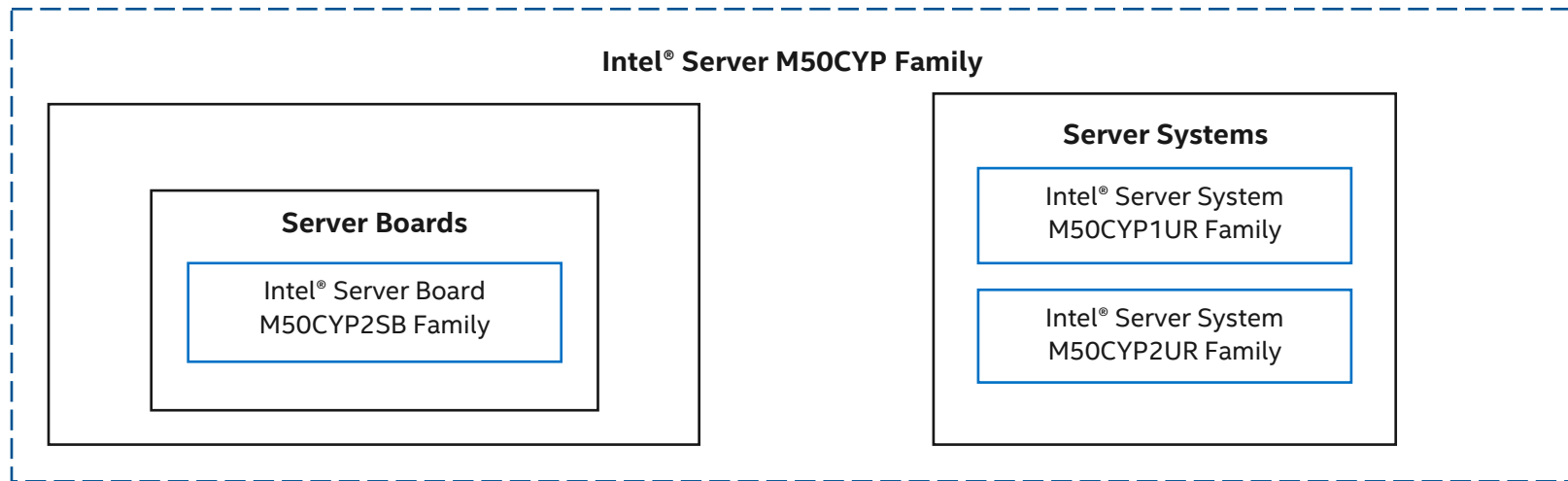
## List of Tables

|   |    |
|---|----|
| Table 1. 3 <sup>rd</sup> Gen Intel® Xeon® Scalable Processor Family Feature Comparison .....            | 13 |
| Table 2. DDR4 DIMM Attributes Table for “Identical” and “Like” DIMMs .....                              | 16 |
| Table 3. Product Family Reference Collaterals.....  | 17 |
| Table 4. Intel® Server Board M50CYP2SB Family Features.....   | 21 |
| Table 5. Intel® Server System M50CYP1UR Family Features .....   | 26 |
| Table 6. Intel® Server System M50CYP2UR Family Features .....   | 33 |
| Table 7. Server Board (L3) Family Summary .....   | 38 |
| Table 8. Server System (L6 BIK) Family Summary .....  | 38 |
| Table 9. Intel® Server Board M50CYP2SB Family Options.....  | 40 |
| Table 10. Intel® Server System M50CYP1UR204 product Specifications and Configuration Requirements ..... | 44 |
| Table 11. Intel® Server System M50CYP1UR212 Specifications and Configuration Requirements.....          | 45 |
| Table 12. Intel® Server System M50CYP2UR208 product Specifications and Configuration Requirements ..... | 47 |
| Table 13. Intel® Server System M50CYP2UR312 Product Specifications and Configuration Requirements ..... | 48 |
| Table 14. Multiport Mini SAS HD Cable Connectors .....  | 51 |
| Table 15. x4 PCIe* SlimSAS Cable Connectors .....   | 51 |
| Table 16. x8 PCIe* SlimSAS Cable Connectors .....   | 51 |
| Table 17. Data Cable Connector Identification.....  | 52 |
| Table 18. SAS/SATA/NVMe* Data Cable Kit Description and Order Information.....                          | 54 |
| Table 19. Data Cable Guide for Intel® Server System M50CYP1UR204 .....                                  | 61 |
| Table 20. Data Cable Guide for Intel® Server System M50CYP1UR212 .....                                  | 63 |
| Table 21. M50CYP2UR208 Cable Guide for up to 8 Front Drive Bays .....                                   | 66 |
| Table 22. 2U 2.5" SAS/SATA Cable Guide for 9–16 Front Drive Bays .....                                  | 69 |
| Table 23. 2U 2.5" PCIe* NVMe* Cable Guide for 9–16 Front Drive Bays .....                               | 71 |
| Table 24. 2U 2.5" SAS / SATA Cable Guide for 17–24 Front Drive Bays .....                               | 73 |
| Table 25. 2U 2.5" PCIe* NVMe* Cable Guide for 17–24 Front Drive Bays.....                               | 75 |
| Table 26. 2U 12 x 3.5" M50CYP2UR312 SAS / SATA / NVMe* Cable Guide.....                                 | 76 |
| Table 27. 1U Riser Card Option .....  | 78 |
| Table 28. 2U Riser Card Options .....   | 80 |
| Table 29. Intel® Ethernet Network Adapters for OCP* .....   | 85 |

|   |     |
|---|-----|
| Table 30. Intel® Integrated RAID Module RMSP3 Product Family – SAS 3.0 (12 Gb/s) .....      | 87  |
| Table 31. Intel® RAID Controller Add-in Cards – SAS 3.0 (12 Gb/s).....                      | 88  |
| Table 32. Intel® RAID Controller Add-in Cards – SAS 3.0 (12 Gb/s) and NVMe* PCIe* 4.0 ..... | 89  |
| Table 33. Optional VROC 7.5 Upgrade Key - Supported NVMe* RAID Features.....                | 90  |
| Table 34. Intel® VROC Key Option .....  | 92  |
| Table 35. Intel® RAID Accessory Options.....  | 93  |
| Table 36. Power Supply Modules and Power Cords.....   | 94  |
| Table 37. Rack Mount Kits.....  | 97  |
| Table 38. Miscellaneous Accessory Options .....   | 99  |
| Table 39. Spare and Replacement Parts .....   | 103 |

# 1. Intel® Server M50CYP Family Overview

This document provides a catalog of available Intel server products, accessories, and spares for the Intel® Server M50CYP family.



**Figure 1. Intel® Server M50CYP Family Overview**

For a complete overview of the Intel® Server Board M50CYP2SB family features and functions, see the *Intel® Server Board M50CYP2SB Family Technical Product Specification (TPS)*.

For a complete overview of the Intel® Server System M50CYP1UR family features and functions, see the *Intel® Server System M50CYP1UR Family Technical Product Specification (TPS)*.

For a complete overview of the Intel® Server System M50CYP2UR family features and functions, see the *Intel® Server System M50CYP2UR Family Technical Product Specification (TPS)*.

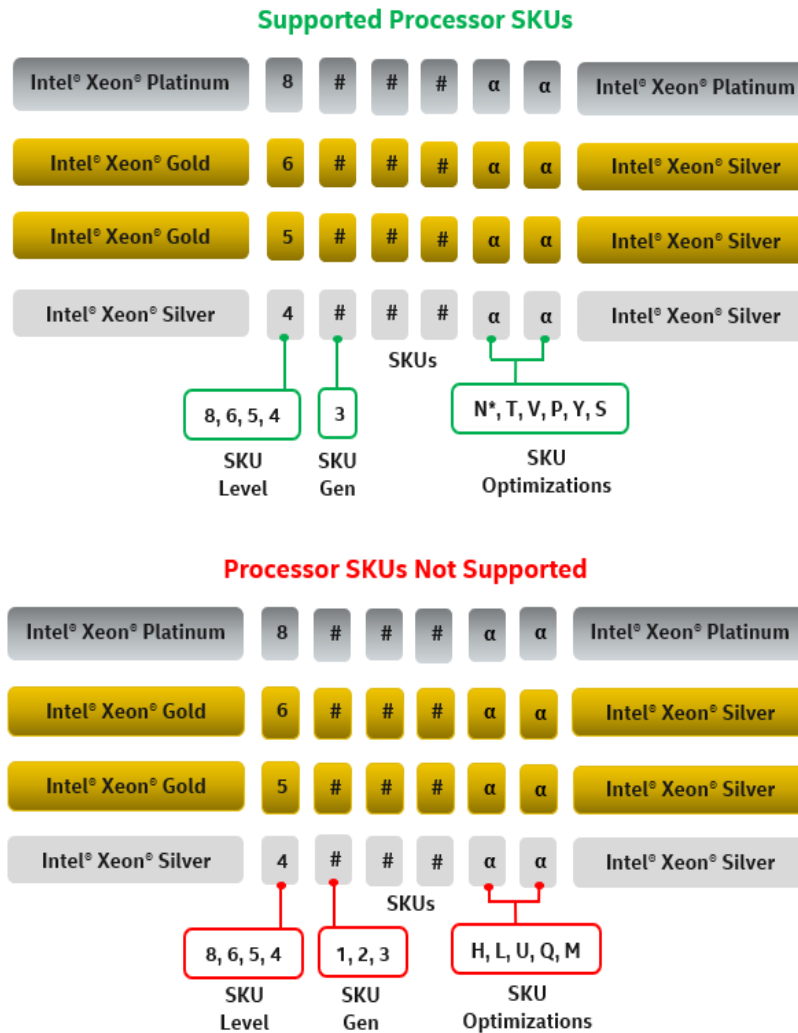
## 1.1 Configuration Overview

The Intel® Server M50CYP family is offered as both server board options and L6 integrated server systems.

- Server board options:
  - **Intel® Server Board M50CYP2SB1U**
  - **Intel® Server Board M50CYP2SBSTD**
- Integrated server system (L6) options:
  - **Intel® Server System M50CYP1UR family** – A family of 1U rack mount server system integrated at level L6 with an Intel® Server Board M50CYP2SB1U and chassis.
  - **Intel® Server System M50CYP2UR family** – A family of 2U rack mount server system integrated at level L6 with an Intel® Server Board M50CYP2SBSTD and chassis.

### 1.1.1 Processor Support

The Intel® Server M50CYP family supports the 3<sup>rd</sup> Gen Intel® Xeon® Scalable processor family. Processor shelves within the product family are identified as shown in the following figure.



**Figure 2. 3<sup>rd</sup> Gen Intel® Xeon® Scalable Processor Identification**

**Note:** Supported 3<sup>rd</sup> Gen Intel® Xeon® Scalable processor SKUs must Not end in (H), (L), (U), (Q), or (M). All other processor SKUs are supported.

**\* Note:** The 8351N SKU is a single-socket optimized SKU and is not supported on the Intel® Server M50CYP family.

The Intel® Server M50CYP family supports the following 3<sup>rd</sup> Gen Intel® Xeon® Scalable processor family shelves:

- Intel® Xeon® Platinum 8300 processors
- Intel® Xeon® Gold 6300 processors
- Intel® Xeon® Gold 5300 processors
- Intel® Xeon® Silver 4300 processors

**Note:** Previous generation Intel® Xeon® processors and previous-generation processor heat sinks are not compatible on server boards and server systems described in this document.

**Table 1. 3<sup>rd</sup> Gen Intel® Xeon® Scalable Processor Family Feature Comparison**

| Feature                              | Platinum 8300 Processors | Gold 6300 Processors | Gold 5300 Processors | Silver 4300 Processor |
|--------------------------------------|--------------------------|----------------------|----------------------|-----------------------|
| # of Intel® UPI Links                | 3                        | 3                    | 3                    | 2                     |
| Intel® UPI Speed                     | 11.2 GT/s                | 11.2 GT/s            | 11.2 GT/s            | 10.4 GT/s             |
| Supported Topologies                 | 2S-2UPI<br>2S-3UPI       | 2S-2UPI<br>2S-3UPI   | 2S-2UPI<br>2S-3UPI   | 2S-2UPI               |
| Node Controller Support              | No                       | No                   | No                   | No                    |
| RAS Capability                       | Advanced                 | Advanced             | Advanced             | Standard              |
| Intel® Turbo Boost Technology        | Yes                      | Yes                  | Yes                  | Yes                   |
| Intel® HT Technology                 | Yes                      | Yes                  | Yes                  | Yes                   |
| Intel® AVX-512 ISA Support           | Yes                      | Yes                  | Yes                  | Yes                   |
| Intel® AVX-512 - # of 512b FMA Units | 2                        | 2                    | 2                    | 2                     |
| # of PCIe* Lanes                     | 64                       | 64                   | 64                   | 64                    |
| Intel® VMD                           | Yes                      | Yes                  | Yes                  | Yes                   |

**Note:** Features may vary between processor SKUs.

Reference 3<sup>rd</sup> Gen Intel® Xeon® Scalable processor specification sheets and product briefs for additional information.

### 1.1.2 Memory Support

The Intel® Server M50CYP family supports the following memory features:

- 32 DIMM slots
  - 16 DIMM slots per processor, eight memory channels per processor
  - Two DIMMs per channel
- Memory capacity
  - Up to 6 TB per processor (processor SKU dependent)
- Memory data transfer rates
  - Up to 3200 MT/s at one or two DIMMs per channel
- Registered DDR4 RDIMM, 3DS-RDIMM, Load Reduced DDR4 (LRDIMM), 3DS-LRDIMM  
**Note:** 3DS = 3 Dimensional Stacking.
- Intel® Optane™ persistent memory 200 series
- DDR4 standard voltage of 1.2 V
- All DDR4 DIMMs must support ECC

### 1.1.3 System Configuration Notes

- The Intel® Server Board M50CYP2SB supports the 3rd Gen Intel® Xeon® Scalable processor family.
- Previous generation Intel® Xeon® processors and Intel® Xeon® Scalable processor families are not supported.
- **Caution:** Installing processors into the processor sockets should be done with great care. Proper processor orientation with the socket should be made before attempting to install the processor. DO NOT touch any of the contact pins within the processor socket. Doing so could result in bending them and rendering the slot inoperable.
- CPU 1 must be populated for Riser Slot #2 and Riser Slot #3 to be functional.
- Do Not install a heat sink on an empty socket.
- For best performance, memory should be populated evenly across channels starting with the BLUE DIMM slot on each channel. For additional details, see the *Intel® Server System M50CYP1UR Family Technical Product Specification (TPS)* or *Intel® Server System M50CYP2UR Family Technical Product Specification (TPS)*.
- **Caution:** Update your server platform to the latest system software posted to RDC before attempting any validation testing. Intel highly recommends that you read the complete Update Instructions and Release Notes for each software component before updating the system.
- In a 1U system, all cables routed to the front drive bay of the server system are routed through the right, in-between the cable walls and the chassis side walls. The exception are cables from the server board SlimSAS connectors that must be routed through the middle of the fan assembly. No cables should be routed above the processors or DIMMs.

- In a 2U system, cables routed to the front of the server system are routed along the chassis side walls. The exception are cables from the server board SlimSAS connectors. These cables must be routed under the fan assembly. No cables should be routed above the processors or DIMMs. The fan assembly must be removed when routing cables. Care should be taken not to pinch any cables when reinstalling the fan assembly.
- The back edge of the server board has a bank of eight diagnostic LEDs that display a sequence of POST codes during the boot process. Should your system hang during POST, the LEDs will display the last POST event run before the hang. The decoder for these POST code LED sequences can be found in the product *Technical Product Specifications (TPS)* document that can be downloaded from RDC.

**Intel DDR4 DIMM Support Disclaimer:**

Intel validates and will only provide support for system configurations where all installed DDR4 DIMMs have matching "Identical" or "Like" attributes. See [Table 2](#). A system configured concurrently with DDR4 DIMMs from different vendors will be supported by Intel if all other DDR4 "Like" DIMM attributes match.

Intel does not perform system validation testing nor will it provide support for system configurations where all populated DDR4 DIMMs do not have matching "Like" DIMM attributes as listed in [Table 2](#).

Intel will only provide support for Intel server systems configured with DDR4 DIMMs that have been validated by Intel and are listed on Intel's Tested Memory list for the given Intel server product family.

Intel configures and ships pre-integrated L9 server systems. All DDR4 DIMMs within a given L9 server system as shipped by Intel will be identical. All installed DIMMs will have matching attributes as those listed in the "Identical" DDR4 DIMM4 Attributes column in [Table 2](#).

When purchasing more than one integrated L9 server system with the same configuration from Intel, Intel reserves the right to use "Like" DIMMs between server systems. At a minimum "Like" DIMMs will have matching DIMM attributes as listed in the table below. However, the DIMM model #, revision #, or vendor may be different.

For warranty replacement, Intel will make every effort to ship back an exact match to the one returned. However, Intel may ship back a validated "Like" DIMM. A "Like" DIMM may be from the same vendor but may not be the same revision # or model #, or it may be an Intel validated DIMM from a different vendor. At a minimum, all "Like" DIMMs shipped from Intel will match attributes of the original part according to the definition of "Like" DIMMs in the following table.

**Table 2. DDR4 DIMM Attributes Table for "Identical" and "Like" DIMMs**

| <ul style="list-style-type: none"> <li>• DDR4 DIMMs are considered "Identical" when ALL listed attributes between the DIMMs match</li> <li>• Two or more DDR4 DIMMs are considered "Like" DIMMs when all attributes minus the Vendor, and/or DIMM Part # and/or DIMM Revision#, are the same.</li> </ul> |                                  |                             |  |
|--|----------------------------------|-----------------------------|--|
| Attribute  | "Identical" DDR4 DIMM Attributes | "Like" DDR4 DIMM Attributes | Possible DDR4 Attribute Values             |
| Vendor   | Match                            | Maybe Different             | Memory Vendor Name                         |
| DIMM Part #  | Match                            | Maybe Different             | Memory Vendor Part #                       |
| DIMM Revision #  | Match                            | Maybe Different             | Memory Vendor Part Revision #              |
| SDRAM Type   | <b>Match</b>                     | <b>Match</b>                | DDR4                                       |
| DIMM Type  | <b>Match</b>                     | <b>Match</b>                | RDIMM, LRDIMM                              |
| Speed (MHz)  | <b>Match</b>                     | <b>Match</b>                | 2666, 2933, 3200                           |
| Voltage  | <b>Match</b>                     | <b>Match</b>                | 1.2V                                       |
| DIMM Size (GB)   | <b>Match</b>                     | <b>Match</b>                | 8GB, 16GB, 32GB, 64GB, 128GB, 256GB        |
| Organization   | <b>Match</b>                     | <b>Match</b>                | 1Gx72; 2Gx72; 4Gx72; 8Gx72; 16Gx72; 32Gx72 |
| DIMM Rank  | <b>Match</b>                     | <b>Match</b>                | 1R, 2R, 4R, 8R                             |
| DRAM Width   | <b>Match</b>                     | <b>Match</b>                | x4, x8                                     |
| DRAM Density   | <b>Match</b>                     | <b>Match</b>                | 8Gb, 16Gb                                  |



## 1.2 Reference Documents and Support Collaterals

For additional information, see the product support collaterals specified in the following table. The following webpage provides support information for the M50CYP family: <https://www.intel.com/content/www/us/en/support/products/200321.html>

**Table 3. Product Family Reference Collaterals**

| Topic   | Document Title or Support Collateral   | Document Classification |
|---|--|-------------------------|
| System integration instructions and service guidance                                    | <i>Intel® Server System M50CYP2UR Family System Integration and Service Guide</i>  | Public                  |
| System integration instructions and service guidance                                    | <i>Intel® Server System M50CYP1UR Family System Integration and Service Guide</i>  | Public                  |
| Technical system-level description  | <i>Intel® Server System M50CYP2UR Family Technical Product Specification</i>   | Public                  |
| Technical system-level description  | <i>Intel® Server System M50CYP1UR Family Technical Product Specification</i>   | Public                  |
| Technical board-level description   | <i>Intel® Server Board M50CYP2SB Family Technical Product Specification</i>  | Public                  |
| Server configuration guidance and compatibility   | <i>Intel® Server M50CYP Family Configuration Guide</i>   | Public                  |
| Information on the Integrated BMC Web Console   | <i>Intel® Integrated Baseboard Management Controller Web Console (Integrated BMC Web Console) User Guide</i><br><i>For the Intel® Server Board D50TNP, M50CYP, and D40AMP Families</i> | Public                  |
| BIOS technical information on Intel® Server M50CYP Family                               | <i>BIOS Firmware External Product Specification (EPS)</i><br><i>For the Intel® Server Boards D50TNP, M50CYP, and D40AMP Families</i>   | Intel Confidential      |
| BIOS setup information on Intel® Server M50CYP Family                                   | <i>BIOS Setup Utility User Guide</i><br><i>For the Intel® Server Boards D50TNP, M50CYP, and D40AMP Families</i>  | Public                  |
| BMC technical information on Intel® Server M50CYP Family                                | <i>Integrated Baseboard Management Controller Firmware External Product Specification</i><br><i>For the Intel® Server System D50TNP, M50CYP, and D40AMP Families</i>                   | Intel Confidential      |
| Base specifications for the IPMI architecture and interfaces                            | <i>Intelligent Platform Management Interface Specification Second Generation v2.0</i>  | Intel Confidential      |
| Specifications for the PCIe* 3.0 architecture and interfaces                            | <i>PCIe* Base Specification, Revision 3.0</i><br><a href="http://www.pcisig.com/specifications">http://www.pcisig.com/specifications</a>   | Public                  |
| Specifications for the PCIe* 4.0 architecture and interfaces                            | <i>PCIe* Base Specification, Revision 4.0</i><br><a href="http://www.pcisig.com/specifications">http://www.pcisig.com/specifications</a>   | Public                  |
| Specification for OCP*  | <i>Open Compute Project* (OCP*) Specification</i>  | Intel Confidential      |
| TPM for PC Client specifications  | <i>TPM PC Client Specifications, Revision 2.0</i>  | Intel Confidential      |
| Functional specifications of 3 <sup>rd</sup> Gen Intel® Xeon® Scalable processor family | <i>3rd Generation Intel® Xeon® Scalable Processors, Codename Ice Lake-SP External Design Specification (EDS): Document IDs: 574451, 574942, 575291</i>                                 | Intel Confidential      |

## Intel® Server M50CYP Family Configuration Guide

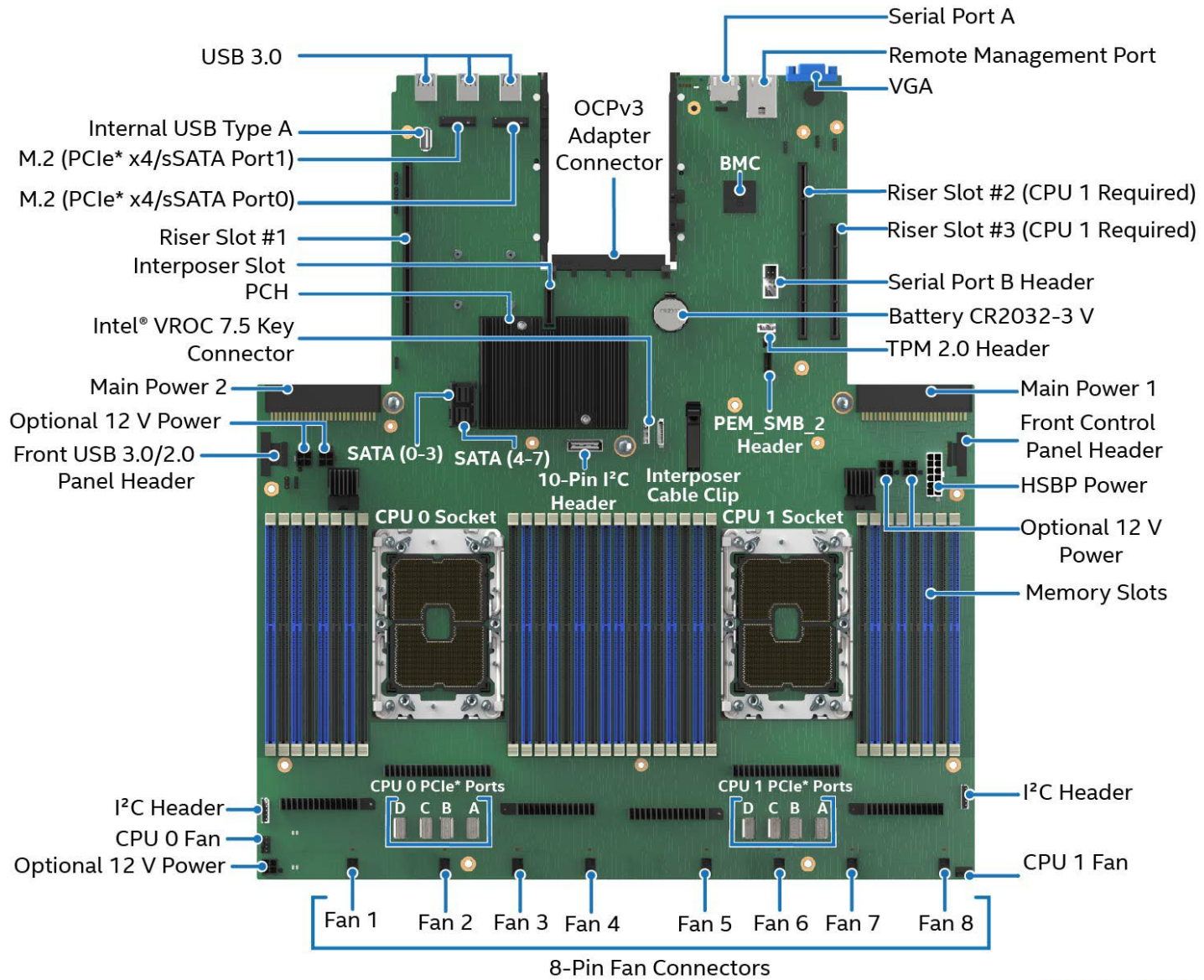
| Topic   | Document Title or Support Collateral   | Document Classification |
|---|--|-------------------------|
| Processor thermal design specifications and recommendations   | <i>3rd Generation Intel® Xeon® Scalable Processor, Codename Ice Lake-SP and Cooper Lake-SP - Thermal and Mechanical Specifications and Design Guide (TMSDG)</i> : Document ID 574080   | Intel Confidential      |
| BIOS and BMC Security Best Practices                          | <i>Intel® Server Systems Baseboard Management Controller (BMC) and BIOS Security Best Practices White Paper</i><br><a href="https://www.intel.com/content/www/us/en/support/articles/000055785/server-products.html">https://www.intel.com/content/www/us/en/support/articles/000055785/server-products.html</a> | Public                  |
| Managing an Intel Server Overview                             | <i>Managing an Intel Server System 2020</i><br><a href="https://www.intel.com/content/www/us/en/support/articles/000057741/server-products.html">https://www.intel.com/content/www/us/en/support/articles/000057741/server-products.html</a>   | Public                  |
| Technical information on Intel® Optane™ persistent memory 200 | <i>Intel® Optane™ Persistent Memory 200 Series Operations Guide</i>  | Intel Confidential      |
| Setup information for Intel® Optane™ persistent memory 200    | <i>Intel® Optane™ Persistent Memory Startup Guide</i>  | Public                  |
| Latest system software updates: BIOS and Firmware             | <i>Intel® System Update Package (SUP) for Intel® Server M50CYP Family</i>  | Public                  |
|   | <i>Intel® System Firmware Update Utility (SYSPWUPDT) - Various operating system support</i>  |                         |
|   | <i>Intel® System Firmware Update Utility User Guide</i>  |                         |
| To obtain full system information                             | <i>Intel® SYSINFO Utility for Intel® Server M50CYP Family</i>  | Public                  |
|   | <i>Intel® Server Information Utility User Guide</i>  |                         |
| To configure, save, and restore various system options        | <i>Intel® SYSCFG Utility for Intel® Server M50CYP Family – Various operating system support</i>  | Public                  |
|   | <i>Intel® Server Configuration Utility User Guide</i>  |                         |
| Product Warranty Information                                  | <i>Warranty Terms and Conditions</i><br><a href="https://www.intel.com/content/www/us/en/support/services/000005886.html">https://www.intel.com/content/www/us/en/support/services/000005886.html</a>  | Public                  |
| Intel® Data Center Manager (Intel® DCM) information           | <i>Intel® Data Center Manager (Intel® DCM) Product Brief</i><br><a href="https://software.intel.com/content/www/us/en/develop/download/dcm-product-brief.html">https://software.intel.com/content/www/us/en/develop/download/dcm-product-brief.html</a>  | Public                  |
|   | <i>Intel® Data Center Manager (Intel® DCM) Console User Guide</i><br><a href="https://software.intel.com/content/www/us/en/develop/download/dcm-user-guide.html">https://software.intel.com/content/www/us/en/develop/download/dcm-user-guide.html</a>   | Public                  |

---

**Note:** Intel Confidential documents are made available under a Non-Disclosure Agreement (NDA) with Intel and must be ordered through your local Intel representative.

---

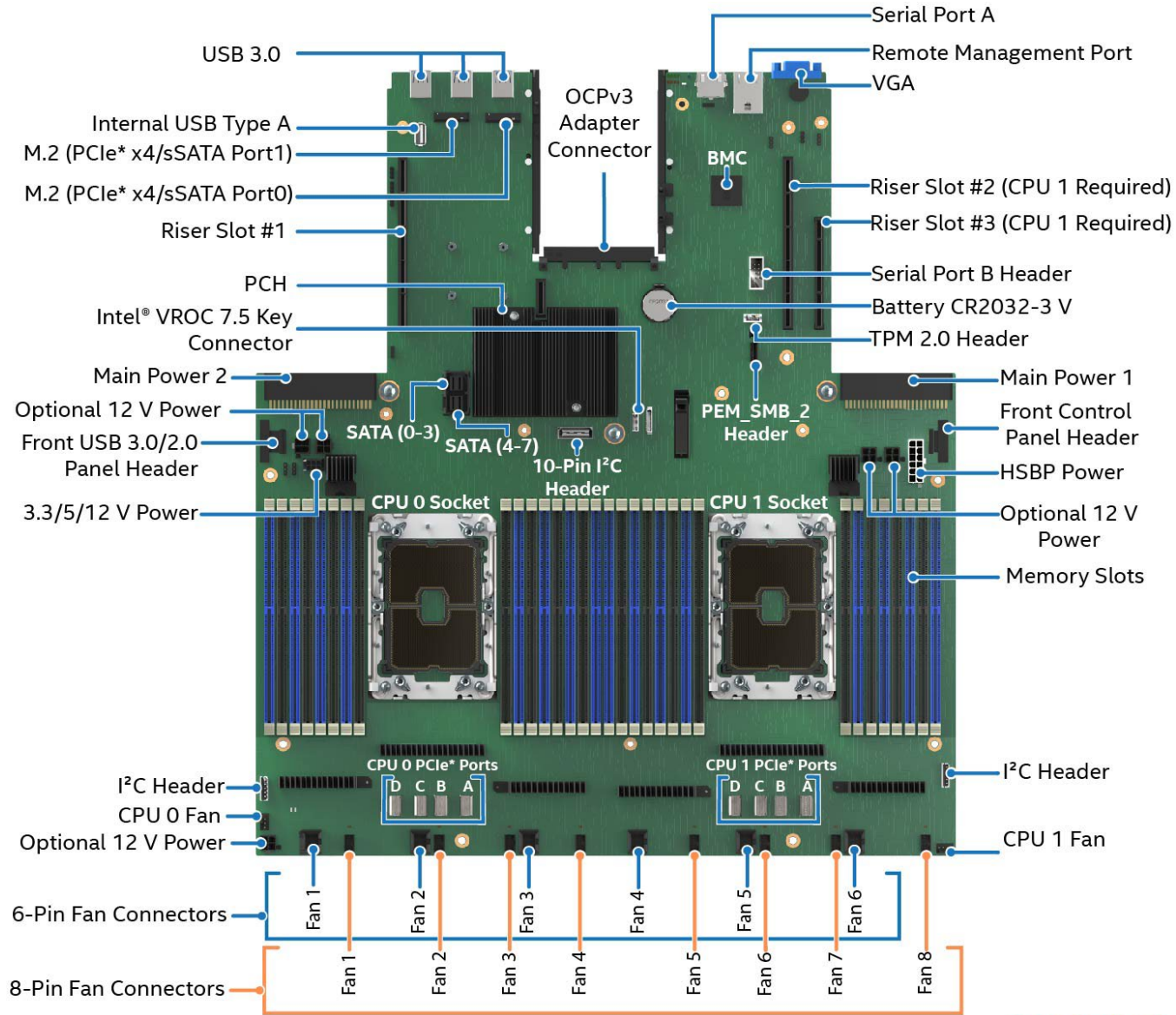
### 1.3 Intel® Server Board M50CYP2SB Family



Ref #: CYP10424

Figure 3. Intel® Server Board M50CYP2SB1U Component / Feature Identification

# Intel® Server Board M50CYP Family Configuration Guide



Ref #: CYP10415

**Figure 4. Intel® Server Board M50CYP2SBSTD Component / Feature Identification**

Table 4 lists the features of the available server boards in the Intel® Server Board M50CYP2SB family.

**Table 4. Intel® Server Board M50CYP2SB Family Features**

| Feature   | Details  |
|---|--|
| <b>Server Board</b>   | <ul style="list-style-type: none"> <li>Intel® Server Board M50CYP2SBSTD and Intel® Server Board M50CYP2SB1U</li> </ul>   |
| <b>Server Board Dimensions</b>                                | <ul style="list-style-type: none"> <li>477.36 mm length x 427.98 mm width x 1.93 mm thickness</li> </ul>   |
| <b>Processor Support</b>                                      | <ul style="list-style-type: none"> <li>Dual Socket-P4 LGA4189</li> <li>Supported 3<sup>rd</sup> Gen Intel® Xeon® Scalable processor family SKUs: <ul style="list-style-type: none"> <li>Intel® Xeon® Platinum 8300 processor</li> <li>Intel® Xeon® Gold 6300 processor</li> <li>Intel® Xeon® Gold 5300 processor</li> <li>Intel® Xeon® Silver 4300 processor</li> </ul> </li> </ul> <hr/> <p><b>Note:</b> Supported 3<sup>rd</sup> Gen Intel® Xeon® Scalable processor SKUs must Not end in (H), (L), (U), (Q), or (M). All other processor SKUs are supported.</p> <hr/> <ul style="list-style-type: none"> <li>Intel® UPI links: up to three at 11.2 GT/s (Platinum and Gold families) or up to two at 10.4 GT/s (Silver family)</li> </ul> <hr/> <p><b>Note:</b> Previous generation Intel® Xeon® processors are not supported.</p> |
| <b>Maximum Supported Processor Thermal Design Power (TDP)</b> | <ul style="list-style-type: none"> <li>3<sup>rd</sup> Gen Intel® Xeon® Scalable processors can operate up to 270 W (server board only)</li> </ul> <hr/> <p><b>Note:</b> The maximum supported processor TDP at the system level may be lower than what the server board can support. Supported power, thermal, and configuration limits of the chosen server chassis need to be considered to determine if the system can support the maximum processor TDP limit of the server board. Refer to the server chassis/system documentation for additional guidance.</p>   |
| <b>PCH Chipset</b>  | <ul style="list-style-type: none"> <li>Intel® C621A Platform Controller Hub (PCH) chipset</li> <li>Embedded features enabled on this server board: <ul style="list-style-type: none"> <li>SATA support</li> <li>USB support</li> <li>PCIe support</li> </ul> </li> </ul>   |
| <b>Memory Support</b>   | <ul style="list-style-type: none"> <li>32 DIMM slots <ul style="list-style-type: none"> <li>16 DIMM slots per processor, eight memory channels per processor</li> <li>Two DIMMs per channel</li> </ul> </li> <li>All DDR4 DIMMs must support ECC</li> <li>Registered DDR4 (RDIMM), 3DS-RDIMM, Load Reduced DDR4 (LRDIMM), 3DS-LRDIMM <p><b>Note:</b> 3DS = 3 Dimensional Stacking</p> </li> <li>Intel® Optane™ persistent memory 200 series</li> <li>Memory capacity <ul style="list-style-type: none"> <li>Up to 6 TB per processor (processor SKU dependent)</li> </ul> </li> <li>Memory data transfer rates <ul style="list-style-type: none"> <li>Up to 3200 MT/s at one or two DIMMs per channel (processor SKU dependent)</li> </ul> </li> <li>DDR4 standard voltage of 1.2V</li> </ul>  |
| <b>System Fan Support</b>                                     | <ul style="list-style-type: none"> <li>Six 6-pin fan connectors (<b>Intel® Server Board M50CYP2SBSTD</b>)</li> <li>Eight 8-pin fan connectors (<b>Intel® Server Board M50CYP2SB1U and M50CYP2SBSTD</b>)</li> <li>CPU fan headers (one for each CPU)</li> </ul>   |
| <b>Onboard Network Support</b>                                | Provided by optional Open Compute Project (OCP*) module support. See below.  |

Intel® Server M50CYP Family Configuration Guide

| Feature  | Details  |
|--|--|
| <b>Open Compute Project* (OCP*) Module Support</b> | Onboard x16 PCIe* 4.0 OCP 3.0 Mezzanine connector (Small Form-Factor) slot supports the following Intel accessory options: <ul style="list-style-type: none"><li>• Dual port, RJ45, 10/1 GbE, - iPC – X710T2LOCPV3</li><li>• Quad port, SFP+ DA, 4x 10 GbE – iPC- X710DA4OCPV3</li><li>• Dual Port, QSFP28 100/50/25/10 GbE – iPC- E810CQDA2OCPV3</li><li>• Dual Port, SFP28 25/10 GbE – iPC – E810XXVDA2OCPV3</li></ul> |

| Feature            | Details  |
|--------------------|--|
| Riser Card Support | <p>Concurrent support for up to three riser cards with support for up to eight PCIe* add-in cards. In the below description FH = Full Height, FL = Full Length, HL =Half Length, LP = Low Profile.</p> <p><b><u>Riser Slot #1:</u></b></p> <ul style="list-style-type: none"> <li>• Riser Slot #1 supports x32 PCIe* lanes, routed from CPU 0</li> <li>• PCIe* 4.0 support for up to 64 GB/s</li> </ul> <p><b>Riser Slot #1 supports the following Intel Riser Card options:</b></p> <ul style="list-style-type: none"> <li>• Two PCIe* slot riser card supporting (one) - FH/FL double-width slot (x16 electrical, x16 mechanical) + (one) - FH/HL single-width slot (x16 electrical, x16 mechanical) iPC – CYP2URISER1DBL</li> <li>• Three PCIe* slot riser card supporting (one) - FH/FL single-width slot (x16 electrical, x16 mechanical) + (one) - FH/FL single-width slot (x8 electrical, x16 mechanical) + (one) - FH/HL single-width slot (x8 electrical, x8 mechanical) iPC – CYP2URISER1STD</li> <li>• NVMe* riser card supporting (one) – HL or FL single-width slot (x16 electrical, x16 mechanical) + (two) - x8 PCIe* NVMe* SlimSAS* connectors, each with a re-timer. iPC – CYP2URISER1RTM</li> <li>• One PCIe* slot riser card supporting (one) – LP/HL, single-width slot (x16 electrical, x16 mechanical) iPC – CYP1URISER1STD</li> </ul> <p><b><u>Riser Slot #2:</u></b></p> <ul style="list-style-type: none"> <li>• Riser Slot #2 supports x32 PCIe* lanes, routed from CPU 1</li> <li>• PCIe* 4.0 support for up to 64 GB/s</li> </ul> <p><b>Riser Slot #2 supports the following Intel Riser Card options:</b></p> <ul style="list-style-type: none"> <li>• Two PCIe* slot riser card supporting (one) - FH/FL double-width slot (x16 electrical, x16 mechanical) + (one) - FH/HL single-width slot (x16 electrical, x16 mechanical) iPC – CYP2URISER2DBL</li> <li>• Three PCIe* slot riser card supporting (one) - FH/FL single-width slot (x16 electrical, x16 mechanical) + (one) - FH/FL single-width slot (x8 electrical, x16 mechanical) + (one) FH/HL single-width slot (x8 electrical, x8 mechanical) iPC – CYP2URISER2STD</li> <li>• One PCIe* slot riser card supporting (one) – LP/HL, single-width slot (x16 electrical, x16 mechanical) iPC – CYP1URISER2STD</li> <li>• NVMe* riser card supporting (one) – LP/HL, single-width slot (x16 electrical, x16 mechanical) + (one) - x8 PCIe* NVMe* SlimSAS* connector with re-timer. iPC – CYP1URISER2KIT</li> </ul> <p><b><u>PCIe* Interposer Riser Slot</u></b></p> <ul style="list-style-type: none"> <li>• Interposer riser card supports x8 PCIe* lanes, route from CPU 1</li> <li>• PCIe* 4.0 support for 32 GB/s</li> <li>• PCIe* Interposer Riser Slot supports the Intel interposer riser card as an accessory option. This card supports one PCIe* add-in card (x8 electrical, x8 mechanical). The PCIe* interposer riser card can be used only when it is connected to the PCIe* NVMe* riser card in Riser Slot #2 (iPC – CYP1URISER2KIT). The interposer card uses x8 PCIe* data lanes signals routed from the PCIe* SlimSAS* connector on the PCIe* NVMe* riser card. The Intel accessory kit includes the PCIe* interposer riser card, PCIe* NVMe* riser card, and PCIe* interposer cable. iPC – CYP1URISER2KIT</li> </ul> <p><b><u>Riser Slot #3:</u></b></p> <ul style="list-style-type: none"> <li>• Riser Slot #3 supports x16 PCIe* lanes, route from CPU 1</li> <li>• PCIe* 4.0 support for up to 32 GB/s</li> </ul> <p><b>Riser Slot #3 supports the following Intel Riser Card options:</b></p> <ul style="list-style-type: none"> <li>• Two PCIe* slot riser card supporting (two) LP/HL single-width slots (x16 mechanical, x8 electrical) iPC – CYP2URISER3STD</li> <li>• NVMe* riser card supporting (two) – PCIe* NVMe* SlimSAS* connectors with re-timers iPC – CYPRISER3RTM</li> </ul> |

## Intel® Server M50CYP Family Configuration Guide

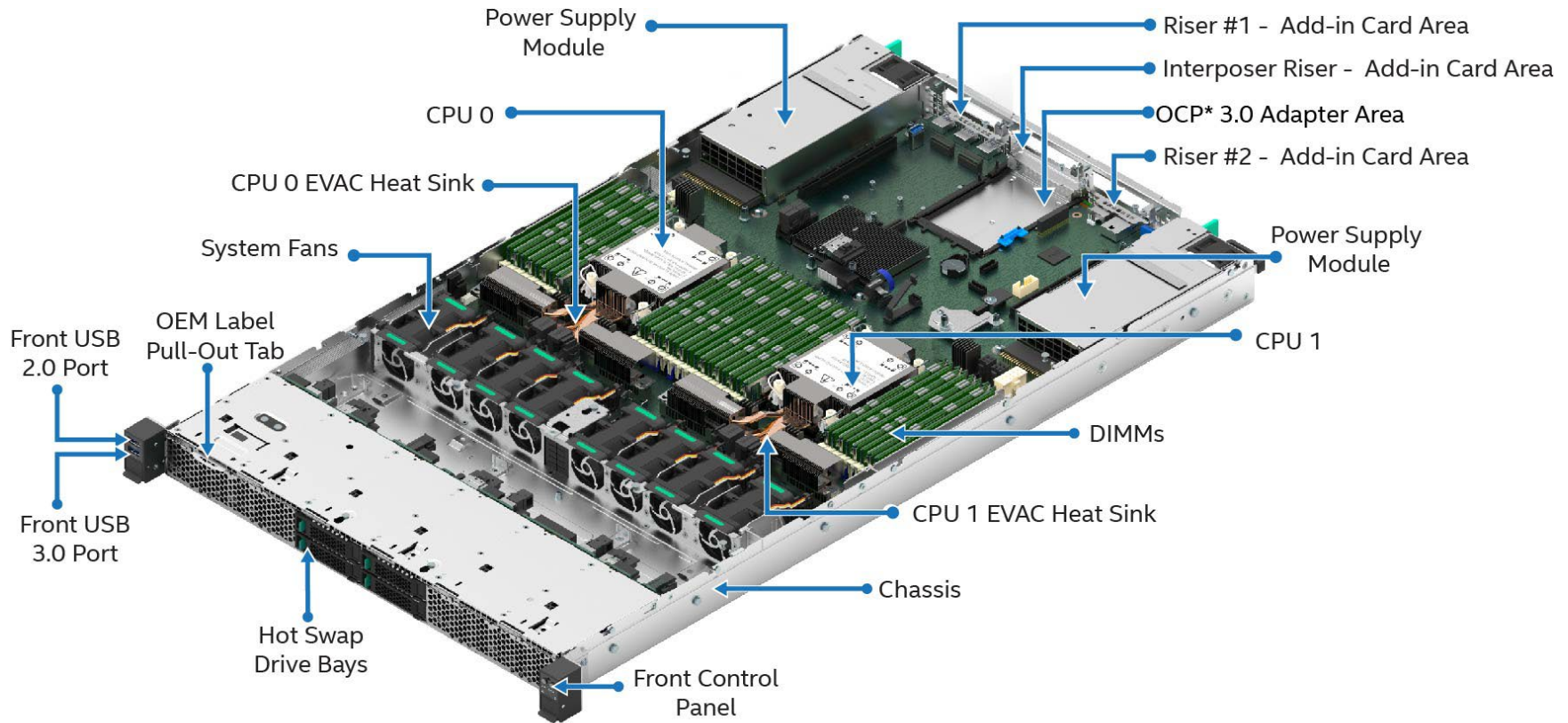
| Feature  | Details   |
|--|---|
| <b>PCIe* NVMe* Support</b>                       | <ul style="list-style-type: none"> <li>• Support for up to 10 PCIe* NVMe* Interconnects                             <ul style="list-style-type: none"> <li>○ Eight onboard SlimSAS* connectors, four per processor</li> <li>○ Two M.2 NVMe*/SATA connectors</li> </ul> </li> <li>• Additional NVMe* support through select PCIe* Riser Card options</li> <li>• Intel® Volume Management Device (Intel® VMD) 2.0 support</li> <li>• Intel® Virtual RAID on CPU 7.5 (Intel® VROC 7.5) support using one of the three types of VROC keys (available as an Intel accessory option)</li> </ul> |
| <b>Video Support</b>                             | <ul style="list-style-type: none"> <li>• Integrated 2D video controller</li> <li>• 128 MB of DDR4 video memory</li> <li>• One VGA DB-15 external connector in the back</li> </ul>   |
| <b>Onboard SATA Support</b>                      | <ul style="list-style-type: none"> <li>• 10 x SATA III ports (6 Gb/s, 3 Gb/s and 1.5 Gb/s transfer rates supported)                             <ul style="list-style-type: none"> <li>○ Two M.2 connectors – SATA / PCIe*</li> <li>○ Two 4-port Mini-SAS HD (SFF-8643) connectors</li> </ul> </li> </ul>   |
| <b>USB Support</b>                               | <ul style="list-style-type: none"> <li>• Three external USB 3.0 connectors intended for rear of chassis use.</li> <li>• Internal 26-pin connector for optional one USB 3.0 port and one USB 2.0 port front panel support</li> <li>• One USB 2.0 internal Type-A header</li> </ul>   |
| <b>Serial Support</b>                            | <ul style="list-style-type: none"> <li>• One external RJ-45 serial-A port connector on the back</li> <li>• One internal DH-10 serial-B port header for optional front or rear serial port support. The port follows DTK pinout specifications.</li> </ul>   |
| <b>Server Management</b>                         | <ul style="list-style-type: none"> <li>• Integrated Baseboard Management Controller (BMC)</li> <li>• Intelligent Platform Management Interface (IPMI) 2.0 compliant</li> <li>• Support for Intel® Data Center Manager (DCM)</li> <li>• Support for Intel® Server Debug and Provisioning Tool (SDPTool)</li> <li>• Redfish* compliant</li> <li>• Support for Intel Server Management Software</li> <li>• Dedicated onboard RJ45 1 GbE management port</li> <li>• Light Guided Diagnostics</li> </ul>   |
| <b>Server Management Processor (SMP)</b>         | <ul style="list-style-type: none"> <li>• ASpeed* AST2500 Advanced PCIe* Graphics and Remote Management Processor</li> <li>• Embedded features enabled on this server board:                             <ul style="list-style-type: none"> <li>○ Baseboard Management Controller (BMC)</li> <li>○ 2D Video Graphics Adapter</li> </ul> </li> </ul>  |
| <b>System Configuration and Recovery Jumpers</b> | <ul style="list-style-type: none"> <li>• BIOS load defaults</li> <li>• BIOS Password clear</li> <li>• Intel® Management Engine firmware force update Jumper</li> <li>• BMC force update</li> <li>• BIOS_SVN Downgrade</li> <li>• BMC_SVN Downgrade</li> </ul>   |



| Feature                 | Details   |
|-------------------------|---|
| <b>Security Support</b> | <ul style="list-style-type: none"> <li>• Intel® Platform Firmware Resilience (Intel® PFR) technology with an I<sup>2</sup>C interface</li> <li>• Intel® Software Guard Extensions (Intel® SGX)</li> <li>• Intel® CBnT – Converged Intel® Boot Guard and Trusted Execution Technology (Intel® TXT)</li> <li>• Intel® Total Memory Encryption (Intel® TME)</li> <li>• Trusted platform module 2.0 (Rest of World) – iPC J33567-151 (accessory option)</li> <li>• Trusted platform module 2.0 (China Version) – iPC J12350-150 (accessory option)</li> </ul> |
| <b>BIOS</b>             | Unified Extensible Firmware Interface (UEFI)-based BIOS (legacy boot not supported)   |

## 1.4 Intel® Server System M50CYP1UR Family

This section gives an overview of the available systems in the Intel® Server System M50CYP1UR family.



Ref #: CYP30238

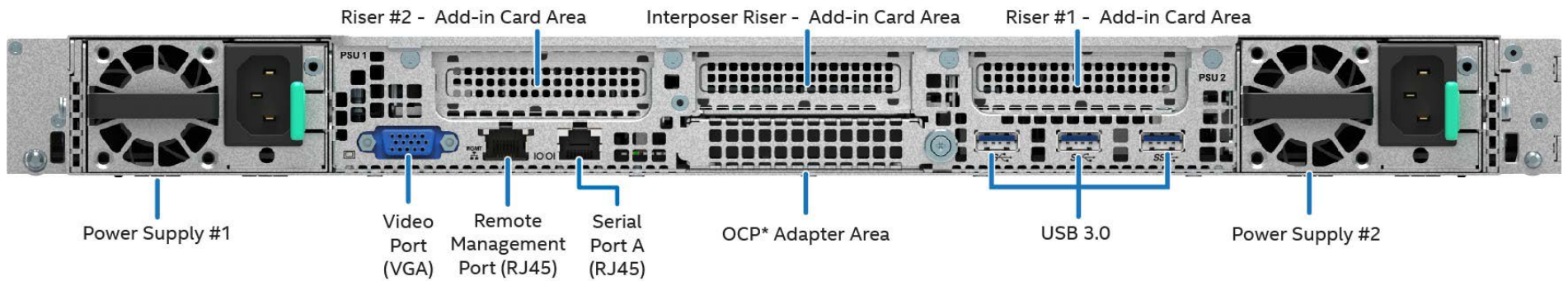
Figure 5. Server System Components Overview



Figure 6. 4 x 2.5" front Drive Bay Configuration – M50CYP1UR204



Figure 7. 12 x 2.5" front Drive Bay Configuration – M50CYP1UR212



Ref #: CYP30147

Figure 8. Back Panel Feature Identification

Table 5. Intel® Server System M50CYP1UR Family Features

| Feature      | Details                         |
|--------------|---------------------------------|
| Chassis Type | 1U rack mount chassis           |
| Server Board | Intel® Server Board M50CYP2SB1U |

## Intel® Server M50CYP Family Configuration Guide

| Feature   | Details  |
|---|--|
| <b>Processor Support</b>                                      | <ul style="list-style-type: none"> <li>• Dual Socket-P4 LGA4189</li> <li>• Supported 3<sup>rd</sup> Gen Intel® Xeon® Scalable processor family SKUs:               <ul style="list-style-type: none"> <li>○ Intel® Xeon® Platinum 8300 processor</li> <li>○ Intel® Xeon® Gold 6300 processor</li> <li>○ Intel® Xeon® Gold 5300 processor</li> <li>○ Intel® Xeon® Silver 4300 processor</li> </ul> </li> </ul> <hr/> <p><b>Note:</b> Supported 3<sup>rd</sup> Gen Intel® Xeon® Scalable processor SKUs must Not end in (H), (L), (U), (Q), or (M). All other processor SKUs are supported.</p> <hr/> <ul style="list-style-type: none"> <li>• Intel® UPI links: up to three at 11.2 GT/s (Platinum and Gold families) or up to two at 10.4 GT/s (Silver family)</li> </ul> <hr/> <p><b>Note:</b> Previous generation Intel® Xeon® processor and Intel® Xeon® Scalable processor families are not supported.</p> |
| <b>Maximum Supported Processor Thermal Design Power (TDP)</b> | <ul style="list-style-type: none"> <li>• 3<sup>rd</sup> Gen Intel® Xeon® Scalable processors up to 270 W.</li> </ul> <hr/> <p><b>Note:</b> The maximum supported processor TDP depends on system configuration.</p>  |
| <b>PCH Chipset</b>  | <ul style="list-style-type: none"> <li>• Intel® C621A Platform Controller Hub (PCH) chipset</li> <li>• Embedded features enabled on this server board:               <ul style="list-style-type: none"> <li>○ SATA support</li> <li>○ USB support</li> <li>○ PCIe* support</li> </ul> </li> </ul>  |
| <b>Memory Support</b>   | <ul style="list-style-type: none"> <li>• 32 DIMM slots               <ul style="list-style-type: none"> <li>○ 16 DIMM slots per processor, eight memory channels per processor</li> <li>○ Two DIMMs per channel</li> </ul> </li> <li>• All DDR4 DIMMs must support ECC</li> <li>• Registered DDR4 (RDIMM), 3DS-RDIMM, Load Reduced DDR4 (LRDIMM), 3DS-LRDIMM               <p style="margin-left: 20px;"><b>Note:</b> 3DS = 3 Dimensional Stacking</p> </li> <li>• Intel® Optane™ persistent memory 200 series</li> <li>• Memory capacity               <ul style="list-style-type: none"> <li>○ Up to 6 TB per processor (processor SKU dependent)</li> </ul> </li> <li>• Memory data transfer rates               <ul style="list-style-type: none"> <li>○ Up to 3200 MT/s at one or two DIMMs per channel (processor SKU dependent)</li> </ul> </li> <li>• DDR4 standard voltage of 1.2V</li> </ul>         |
| <b>System Fans</b>  | <ul style="list-style-type: none"> <li>• Eight managed 40 mm hot swap capable system fans</li> <li>• Integrated fans included with each installed power supply module</li> </ul> <hr/> <p><b>Note:</b> System fan redundancy is supported on specific system configurations.</p>   |
| <b>Power Supply Options</b>                                   | <p>The server system can have up to two power supply modules installed, supporting the following power configurations: 1+0, 1+1 redundant power, and 2+0 combined power.</p> <p>Three power supply options:</p> <ul style="list-style-type: none"> <li>• AC 1300 W Titanium</li> <li>• AC 1600 W Titanium</li> </ul>   |

| Feature   | Details  |
|---|--|
| <b>Server Board Network Support</b>                 | See optional Open Compute Project (OCP*) adapter support below.  |
| <b>Open Compute Project* (OCP*) Adapter Support</b> | <p>Onboard x16 PCIe* 4.0 OCP 3.0 Mezzanine connector (Small Form-Factor) supports the following Intel accessory options:</p> <ul style="list-style-type: none"> <li>• Dual port, RJ45, 10/1 GbE, - iPC- X710T2LOCPV3</li> <li>• Quad port, SFP+ DA, 4x 10 GbE - iPC- X710DA4OCPV3</li> <li>• Dual Port, QSFP28 100/50/25/10 GbE - iPC- E810CQDA2OCPV3</li> <li>• Dual Port, SFP28 25/10 GbE - iPC-E810XXVDA2OCPV3</li> </ul>   |
| <b>Riser Card Support</b>                           | <p>Concurrent support for up to four riser cards, including one PCIe Interposer riser card with support for up to three PCIe* add-in cards. In the below description HL = Half Length, LP = Low Profile.</p> <p><b><u>Riser Slot #1:</u></b></p> <ul style="list-style-type: none"> <li>• Riser Slot #1 supports x16 PCIe* lanes routed from CPU 0</li> <li>• PCIe* 4.0 support for up to 32 GB/s</li> </ul> <p><b>Riser Slot #1 supports the following Intel Riser Card option:</b></p> <ul style="list-style-type: none"> <li>• One PCIe* slot riser card supporting (one) – LP/HL, single-width slot (x16 electrical, x16 mechanical) iPC – CYP1URISER1STD</li> </ul> <p><b><u>Riser Slot #2:</u></b></p> <ul style="list-style-type: none"> <li>• Riser Slot #2 supports x24 PCIe* lanes routed from CPU 1</li> <li>• PCIe* 4.0 support for up to 32 GB/s</li> </ul> <p><b>Riser Slot #2 supports the following Intel Riser Card options:</b></p> <ul style="list-style-type: none"> <li>• One PCIe* slot riser card supporting (one) – LP/HL, single-width slot (x16 electrical, x16 mechanical) iPC – CYP1URISER2STD</li> <li>• NVMe* riser card supporting (one) – LP/HL, single-width slot (x16 electrical, x16 mechanical) + (one) - x8 PCIe* NVMe* SlimSAS* connector with re-timer. Included in iPC – CYP1URISER2KIT</li> </ul> <p><b>PCIe* Interposer Riser Slot (requires PCIe* riser card in Riser Slot #2)</b></p> <ul style="list-style-type: none"> <li>• PCIe* Interposer Riser Slot supports the PCIe* interposer riser card as an accessory option. This card supports one PCIe* add-in card (x8 electrical, x8 mechanical). The PCIe* interposer riser card can be used only when it is connected to the PCIe* NVMe* riser card in Riser Slot #2. The interposer card uses x8 PCIe* data lanes routed from the PCIe* SlimSAS* connector on the PCIe* riser card. The Intel accessory kit includes the PCIe* interposer riser card, PCIe* riser card, and PCIe* interposer cable. iPC – CYP1URISER2KIT</li> </ul> <p><b><u>Riser Slot #3:</u></b></p> <ul style="list-style-type: none"> <li>• Riser Slot #3 supports x16 PCIe* lanes routed from CPU 1</li> <li>• PCIe* 4.0 support for up to 32 GB/s</li> </ul> <p><b>Riser Slot #3 supports the following Intel Riser Card option:</b></p> <ul style="list-style-type: none"> <li>• NVMe* riser card supporting (two) – PCIe* NVMe* SlimSAS* connectors iPC – CYPRISER3RTM</li> </ul> <hr/> <p><b>Note:</b> Riser Slot #3 does not support add-In cards</p> |

## Intel® Server M50CYP Family Configuration Guide

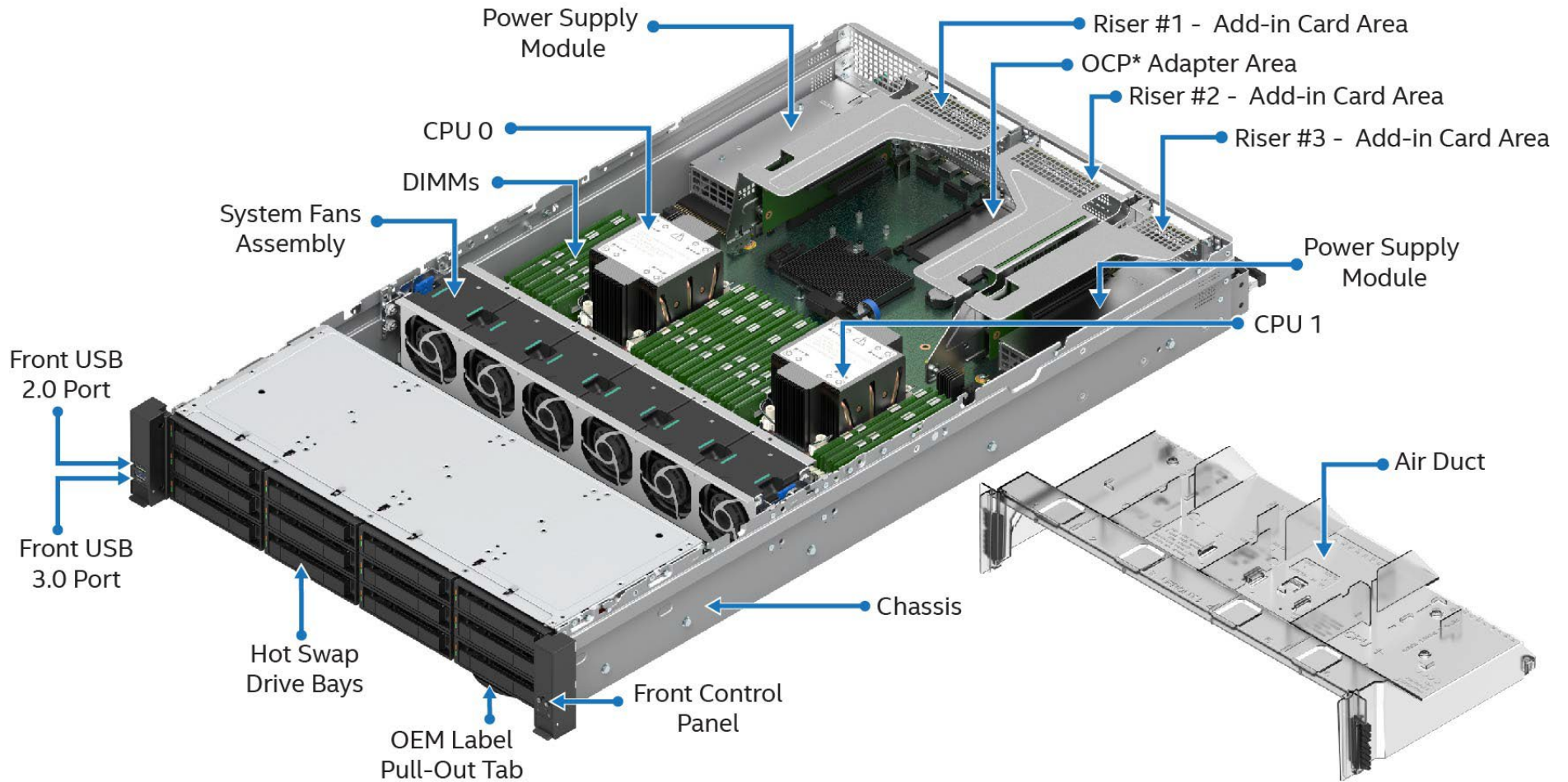
| Feature  | Details  |
|--|--|
| <b>PCIe* NVMe* Support</b>                       | <ul style="list-style-type: none"> <li>• Support for up to 10 PCIe* NVMe* Interconnects                             <ul style="list-style-type: none"> <li>○ Eight server board SlimSAS* connectors, four per processor</li> <li>○ Two M.2 NVMe*/SATA connectors</li> </ul> </li> <li>• Additional NVMe* support through select Riser Card options</li> <li>• Intel® Volume Management Device 2.0 (Intel® VMD 2.0) support</li> <li>• Intel® Virtual RAID on CPU 7.5 (Intel® VROC 7.5) support using one of the three types of VROC keys (available as an Intel accessory option)</li> </ul> |
| <b>Video Support</b>                             | <ul style="list-style-type: none"> <li>• Integrated 2D video controller</li> <li>• 128 MB of DDR4 video memory</li> <li>• One VGA DB-15 external connector in the back</li> </ul>  |
| <b>Server Board SATA Support</b>                 | <ul style="list-style-type: none"> <li>• 10 x SATA III ports (6 Gb/s, 3 Gb/s and 1.5 Gb/s transfer rates supported)                             <ul style="list-style-type: none"> <li>○ Two M.2 connectors – SATA / PCIe*</li> <li>○ Two 4-port Mini-SAS HD (SFF-8643) connectors</li> </ul> </li> </ul>  |
| <b>USB Support</b>                               | <ul style="list-style-type: none"> <li>• Three USB 3.0 connectors on the back panel</li> <li>• One USB 3.0 and one USB 2.0 connector on the front panel</li> <li>• One USB 2.0 internal Type-A connector</li> </ul>  |
| <b>Serial Support</b>                            | <ul style="list-style-type: none"> <li>• One external RJ-45 Serial Port A connector on the back panel</li> <li>• One internal DH-10 Serial Port B header for optional front or rear serial port support. The port follows the DTK pinout specifications.</li> </ul>  |
| <b>Front Drive Bay Options</b>                   | <ul style="list-style-type: none"> <li>• 4 x 2.5" SAS/SATA/NVMe* hot swap drive bays</li> <li>• 12 x 2.5" SAS/SATA/NVMe* hot swap drive bays</li> </ul>  |
| <b>Server Management</b>                         | <ul style="list-style-type: none"> <li>• Integrated Baseboard Management Controller (BMC)</li> <li>• Intelligent Platform Management Interface (IPMI) 2.0 compliant</li> <li>• Redfish* compliant</li> <li>• Support for Intel® Data Center Manager (DCM)</li> <li>• Support for Intel® Server Debug and Provisioning Tool (SDPTool)</li> <li>• Dedicated server board RJ45 1 GbE management port</li> <li>• Light Guided Diagnostics</li> </ul>   |
| <b>Server Management Processor (SMP)</b>         | <ul style="list-style-type: none"> <li>• ASpeed* AST2500 Advanced PCIe Graphics and Remote Management Processor</li> <li>• Embedded features enabled on this server board:                             <ul style="list-style-type: none"> <li>○ Baseboard Management Controller (BMC)</li> <li>○ 2D Video Graphics Adapter</li> </ul> </li> </ul>  |
| <b>System Configuration and Recovery Jumpers</b> | <ul style="list-style-type: none"> <li>• BIOS load defaults</li> <li>• BIOS Password clear</li> <li>• Intel® Management Engine firmware force update Jumper</li> <li>• BMC force update</li> <li>• BIOS_SVN Downgrade</li> <li>• BMC_SVN Downgrade</li> </ul> <p>For more information, see the <i>Intel® Server Board M50CYP2SB Family Technical Product Specification (TPS)</i>.</p>  |

## Intel® Server M50CYP Family Configuration Guide

| Feature   | Details  |
|---|--|
| <b>Security Support</b>                               | <ul style="list-style-type: none"> <li>• Intel® Platform Firmware Resilience (Intel® PFR) technology with an I<sup>2</sup>C interface</li> <li>• Intel® Software Guard Extensions (Intel® SGX)</li> <li>• Intel® CnT – Converged Intel® Boot Guard and Trusted Execution Technology (Intel® TXT)</li> <li>• Intel® Total Memory Encryption (Intel® TME)</li> <li>• Trusted platform module 2.0 (Rest of World) – iPC J33567-151 (accessory option)</li> <li>• Trusted platform module 2.0 (China Version) – iPC J12350-150 (accessory option)</li> </ul> |
| <b>Supported Rack Mount Kit<br/>Accessory Options</b> | <ul style="list-style-type: none"> <li>• <b>CYPHALFEXTRAIL</b> – Value Rack Mount Rail Kit</li> <li>• <b>CYPFULLEXTRAIL</b> – Premium Rail Kit with cable management arm (CMA) support</li> <li>• <b>AXXCMA2</b> – Cable Management Arm (supports <b>CYPFULLEXTRAIL</b> only)</li> </ul>   |
| <b>BIOS</b>   | Unified Extensible Firmware Interface (UEFI)-based BIOS (legacy boot not supported)  |

## 1.5 Intel® Server System M50CYP2UR Family

This section gives an overview of the available systems in the Intel® Server System M50CYP2UR family.



Ref #: CYP20088

Figure 9. Intel® Server System M50CYP2UR Feature Set Identification



Figure 10. 2U 8 x 2.5" Front Drive Bay Configuration – M50CYP2UR208

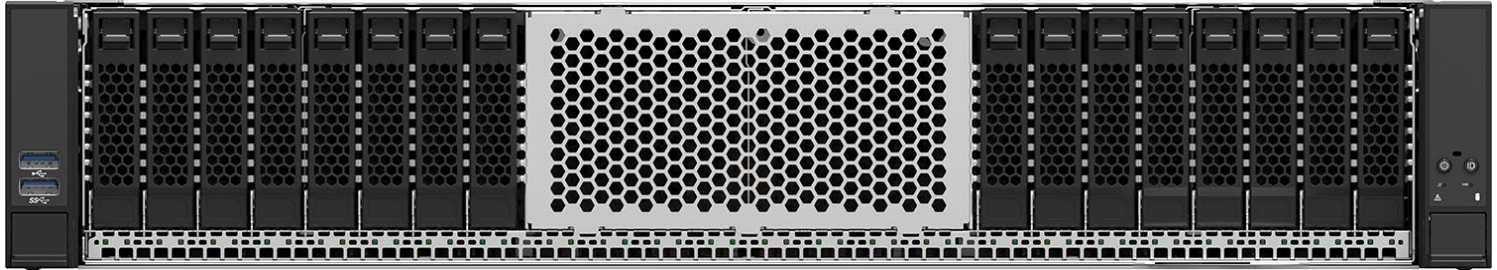


Figure 11. 2U 16 x 2.5" Front Drive Bay Configuration (based on M50CYP2UR208)

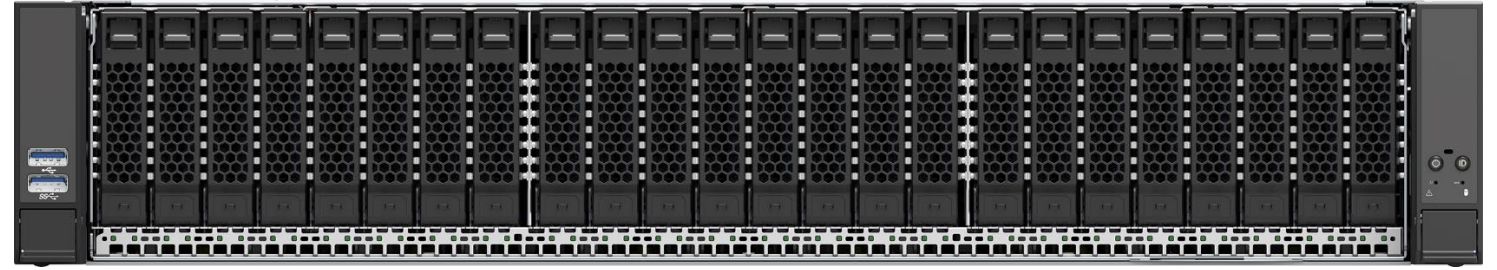


Figure 12. 2U 24 x 2.5" Front Drive Bay Configuration (based on M50CYP2UR208)





Figure 13. 2U 12 x 3.5" Front Drive Bay Configuration – M50CYP2UR312

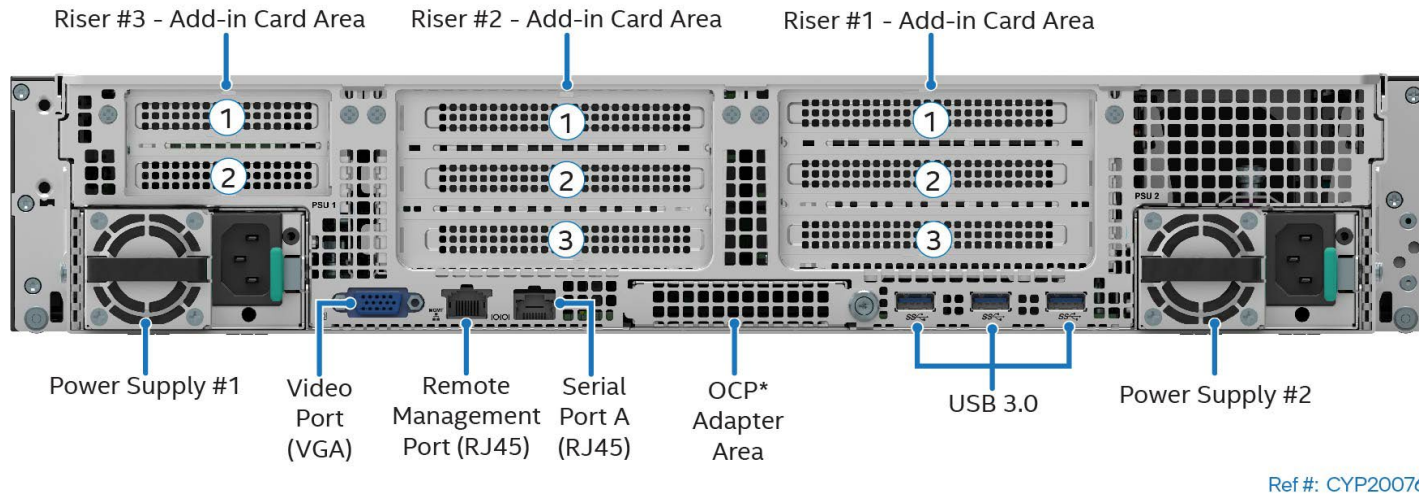


Figure 14. 2U Back Panel Feature Identification

Table 6. Intel® Server System M50CYP2UR Family Features

| Feature      | Details                          |
|--------------|----------------------------------|
| Chassis Type | 2U rack mount chassis            |
| Server Board | Intel® Server Board M50CYP2SBSTD |

## Intel® Server M50CYP Family Configuration Guide

| Feature   | Details  |
|---|--|
| <b>Processor Support</b>                                      | <ul style="list-style-type: none"> <li>• Dual Socket-P4 LGA4189</li> <li>• Supported 3<sup>rd</sup> Gen Intel® Xeon® Scalable processor family SKUs:                             <ul style="list-style-type: none"> <li>○ Intel® Xeon® Platinum 8300 processor</li> <li>○ Intel® Xeon® Gold 6300 processor</li> <li>○ Intel® Xeon® Gold 5300 processor</li> <li>○ Intel® Xeon® Silver 4300 processor</li> </ul> </li> </ul> <hr/> <p><b>Note:</b> Supported 3<sup>rd</sup> Gen Intel® Xeon® Scalable processor SKUs must Not end in (H), (L), (U), (Q), or (M). All other processor SKUs are supported.</p> <hr/> <ul style="list-style-type: none"> <li>• Intel® UPI links: up to three at 11.2 GT/s (Platinum and Gold families) or up to two at 10.4 GT/s (Silver family)</li> </ul> <hr/> <p><b>Note:</b> Previous generation Intel® Xeon® processor and Intel® Xeon® Scalable processor families are not supported.</p>         |
| <b>Maximum Supported Processor Thermal Design Power (TDP)</b> | <ul style="list-style-type: none"> <li>• 3<sup>rd</sup> Gen Intel® Xeon® Scalable processors up to 270 W.</li> </ul> <hr/> <p><b>Note:</b> The maximum supported processor TDP depends on system configuration.</p>  |
| <b>PCH Chipset</b>  | <ul style="list-style-type: none"> <li>• Intel® C621A Platform Controller Hub (PCH) chipset</li> <li>• Embedded features enabled on this server board:                             <ul style="list-style-type: none"> <li>○ SATA support</li> <li>○ USB support</li> <li>○ PCIe* support</li> </ul> </li> </ul>  |
| <b>Memory Support</b>   | <ul style="list-style-type: none"> <li>• 32 DIMM slots                             <ul style="list-style-type: none"> <li>○ 16 DIMM slots per processor, eight memory channels per processor</li> <li>○ Two DIMMs per channel</li> </ul> </li> <li>• All DDR4 DIMMs must support ECC</li> <li>• Registered DDR4 (RDIMM), 3DS-RDIMM, Load Reduced DDR4 (LRDIMM), 3DS-LRDIMM                             <p><b>Note:</b> 3DS = 3 Dimensional Stacking</p> </li> <li>• Intel® Optane™ persistent memory 200 series</li> <li>• Memory capacity                             <ul style="list-style-type: none"> <li>○ Up to 6 TB per processor (processor SKU dependent)</li> </ul> </li> <li>• Memory data transfer rates                             <ul style="list-style-type: none"> <li>○ Up to 3200 MT/s at one or two DIMMs per channel (processor SKU dependent)</li> </ul> </li> <li>• DDR4 standard voltage of 1.2 V</li> </ul> |
| <b>System Fans</b>  | <ul style="list-style-type: none"> <li>• Six managed 60 mm hot swap capable system fans</li> <li>• Integrated fans included with each installed power supply module</li> </ul>   |
| <b>Power Supply Options</b>                                   | <p>The server system can have up to two power supply modules installed, supporting the following power configurations: 1+0, 1+1 redundant power, and 2+0 combined power.</p> <p>Three power supply options:</p> <ul style="list-style-type: none"> <li>• AC 1300 W Titanium</li> <li>• AC 1600 W Titanium</li> <li>• AC 2100 W Platinum</li> </ul>   |
| <b>Onboard Network Support</b>                                | <p>Provided by optional Open Compute Project (OCP*) adapter support. See below.</p>  |

| Feature  | Details   |
|--|---|
| <p><b>Open Compute Project* (OCP*) Adapter Support</b></p> | <p>Server board x16 PCIe* 4.0 OCP 3.0 Mezzanine connector (Small Form-Factor) slot supports the following Intel accessory options:</p> <ul style="list-style-type: none"> <li>• Dual port, RJ45, 10/1 GbE - iPC- X710T2LOCPV3</li> <li>• Quad port, SFP+ DA, 4x 10 GbE - iPC- X710DA4OCPV3</li> <li>• Dual Port, QSFP28 100/50/25/10 GbE - iPC- E810CQDA2OCPV3</li> <li>• Dual Port, SFP28 25/10 GbE - iPC-E810XXVDA2OCPV3</li> </ul>   |
| <p><b>Riser Card Support</b></p>                           | <p>Concurrent support for up to three riser cards with support for up to eight PCIe* add-in cards. In the below description FH = Full Height, FL = Full Length, HL =Half Length, LP = Low Profile.</p> <p><b><u>Riser Slot #1:</u></b></p> <ul style="list-style-type: none"> <li>• Riser Slot #1 supports x32 PCIe* lanes, routed from CPU 0</li> <li>• PCIe* 4.0 support for up to 64 GB/s</li> </ul> <p><b>Riser Slot #1 supports the following Intel Riser Card options:</b></p> <ul style="list-style-type: none"> <li>• Two PCIe* slot riser card supporting (one) - FH/FL double-width slot (x16 electrical, x16 mechanical) + (one) - FH/HL single-width slot (x16 electrical, x16 mechanical) iPC – CYP2URISER1DBL</li> <li>• Three PCIe* slot riser card supporting (one) - FH/FL single-width slot (x16 electrical, x16 mechanical) + (one) - FH/FL single-width slot (x8 electrical, x16 mechanical) + (one) - FH/HL single-width slot (x8 electrical, x8 mechanical) iPC – CYP2URISER1STD</li> <li>• NVMe* riser card supporting (one) – HL or FL single-width slot (x16 electrical, x16 mechanical) + (two) - x8 PCIe* NVMe* SlimSAS* connectors, each with a re-timer. iPC – CYP2URISER1RTM</li> </ul> <p><b><u>Riser Slot #2:</u></b></p> <ul style="list-style-type: none"> <li>• Riser Slot #2 supports x32 PCIe* lanes, routed from CPU 1</li> <li>• PCIe* 4.0 support for up to 64 GB/s</li> </ul> <p><b>Riser Slot #2 supports the following Intel Riser Card options:</b></p> <ul style="list-style-type: none"> <li>• Two PCIe* slot riser card supporting (one) - FH/FL double-width slot (x16 electrical, x16 mechanical) + (one) - FH/HL single-width slot (x16 electrical, x16 mechanical) iPC – CYP2URISER2DBL</li> <li>• Three PCIe* slot riser card supporting (one) - FH/FL single-width slot (x16 electrical, x16 mechanical) + (one) - FH/FL single-width slot (x8 electrical, x16 mechanical) + (one) FH/HL single-width slot (x8 electrical, x8 mechanical) iPC – CYP2URISER2STD</li> </ul> <p><b><u>Riser Slot #3:</u></b></p> <ul style="list-style-type: none"> <li>• Riser Slot #3 supports x16 PCIe* lanes, route from CPU 1</li> <li>• PCIe* 4.0 support for up to 32 GB/s</li> </ul> <p><b>Riser Slot #3 supports the following Intel Riser Card options:</b></p> <ul style="list-style-type: none"> <li>• Two PCIe* slot riser card supporting (two) LP/HL single-width slots (x8 electrical, x16 mechanical) iPC – CYP2URISER3STD</li> <li>• NVMe* riser card supporting (two) – PCIe* NVMe* SlimSAS* connectors with re-timers iPC – CYP2URISER3RTM</li> </ul> |

## Intel® Server M50CYP Family Configuration Guide

| Feature  | Details   |
|--|---|
| <b>PCIe* NVMe* Support</b>                       | <ul style="list-style-type: none"> <li>• Support for up to 10 PCIe* NVMe* Interconnects                             <ul style="list-style-type: none"> <li>○ Eight server board SlimSAS* connectors, four per processor</li> <li>○ Two M.2 NVMe/SATA connectors</li> </ul> </li> <li>• Additional NVMe* support through select Riser Card options</li> <li>• Intel® Volume Management Device (Intel® VMD) 2.0 support</li> <li>• Intel® Virtual RAID on CPU 7.5 (Intel® VROC 7.5) support using one of the three types of VROC keys (available as an Intel accessory option)</li> </ul> |
| <b>Video Support</b>                             | <ul style="list-style-type: none"> <li>• Integrated 2D video controller</li> <li>• 128 MB of DDR4 video memory</li> <li>• One VGA DB-15 external connector in the back</li> </ul>   |
| <b>Onboard SATA Support</b>                      | <ul style="list-style-type: none"> <li>• 10 x SATA III ports (6 Gb/s, 3 Gb/s and 1.5 Gb/s transfer rates supported)                             <ul style="list-style-type: none"> <li>○ Two M.2 connectors – SATA/PCIe*</li> <li>○ Two 4-port Mini-SAS HD (SFF-8643) connectors</li> </ul> </li> </ul>   |
| <b>USB Support</b>                               | <ul style="list-style-type: none"> <li>• Three USB 3.0 connectors on the back panel</li> <li>• One USB 3.0 and one USB 2.0 connector on the front panel</li> <li>• One USB 2.0 internal Type-A connector</li> </ul>   |
| <b>Serial Support</b>                            | <ul style="list-style-type: none"> <li>• One external RJ-45 Serial Port A connector on the back panel</li> <li>• One internal DH-10 Serial Port B header for optional front or rear serial port support. The port follows DTK pinout specifications.</li> </ul>   |
| <b>Front Drive Bay Options</b>                   | <ul style="list-style-type: none"> <li>• 8 x 2.5" SAS/SATA/NVMe* hot swap drive bays</li> <li>• 16 x 2.5" SAS/SATA/NVMe* hot swap drive bays</li> <li>• 24 x 2.5" SAS/SATA/NVMe* hot swap drive bays</li> <li>• 12 x 3.5" SAS/SATA hot swap drive bays (supports up to 4 NVMe* drives)</li> </ul>   |
| <b>Server Management</b>                         | <ul style="list-style-type: none"> <li>• Integrated Baseboard Management Controller (BMC)</li> <li>• Intelligent Platform Management Interface (IPMI) 2.0 compliant</li> <li>• Redfish* compliant</li> <li>• Support for Intel® Data Center Manager (DCM)</li> <li>• Support for Intel® Server Debug and Provisioning Tool (SDPTool)</li> <li>• Support for Intel® Server Management Software</li> <li>• Dedicated server board RJ45 1 GbE management port</li> <li>• Light Guided Diagnostics</li> </ul>   |
| <b>Server Management Processor (SMP)</b>         | <ul style="list-style-type: none"> <li>• ASpeed* AST2500 Advanced PCIe Graphics and Remote Management Processor</li> <li>• Embedded features enabled on this server board:                             <ul style="list-style-type: none"> <li>○ Baseboard Management Controller (BMC)</li> <li>○ 2D Video Graphics Adapter</li> </ul> </li> </ul>   |
| <b>System Configuration and Recovery Jumpers</b> | <ul style="list-style-type: none"> <li>• BIOS load defaults</li> <li>• BIOS Password clear</li> <li>• Intel® Management Engine firmware force update Jumper</li> <li>• BMC force update</li> <li>• BIOS_SVN Downgrade</li> <li>• BMC_SVN Downgrade</li> </ul> <p>For more information, see the <i>Intel® Server Board M50CYP2SB Family Technical Product Specification (TPS)</i>.</p>   |

## Intel® Server M50CYP Family Configuration Guide

| Feature   | Details   |
|---|---|
| <b>Security Support</b>                               | <ul style="list-style-type: none"> <li>• Intel® Platform Firmware Resilience (Intel® PFR) technology with an I<sup>2</sup>C interface</li> <li>• Intel® Software Guard Extensions (Intel® SGX)</li> <li>• Intel® CbNt – Converged Intel® Boot Guard and Trusted Execution Technology (Intel® TXT)</li> <li>• Intel® Total Memory Encryption (Intel® TME)</li> <li>• Trusted platform module 2.0 (Rest of World) – iPC J33567-151 (accessory option)</li> <li>• Trusted platform module 2.0 (China Version) – iPC J12350-150 (accessory option)</li> </ul> |
| <b>Supported Rack Mount Kit<br/>Accessory Options</b> | <p><b>CYPHALFEXTRAIL</b> –Value Rack Mount Rail Kit</p> <p><b>CYPFULLEXTRAIL</b> – Premium Rail Kit with cable management arm (CMA) support</p> <p><b>AXXCMA2</b> – Cable Management Arm (supports <b>CYPFULLEXTRAIL</b> only)</p>  |
| <b>BIOS</b>   | Unified Extensible Firmware Interface (UEFI)-based BIOS (legacy boot not supported)   |

## 1.6 Available Server Board, Chassis, and System SKU Summary

The following tables provide an overview of available Intel product codes for server boards and systems within the Intel® Server M50CYP family. Each line item identifies key features supported in the shipping Intel SKU. Additional order code information and full product descriptions for each option are provided in later sections.

The following terms are used in the tables:

- **N/A:** Not applicable.
- **Opt:** Accessory option sold separately.
- **Yes:** Option included.
- **BIK:** Intel term for integrated (L6 and L9) system product.
- **L3:** Server System Building Block – Server board only
- **L6:** Integrated system – Chassis and server board, with no processors, memory, power supply, or storage devices.

**Table 7. Server Board (L3) Family Summary**

| Intel Product Code (iPC) | # of CPU sockets | # of DIMM Slots | # of Riser Slots | Onboard SATA ports (6 Gb) | Onboard NVMe* Ports | Intel® SAS RAID Module support | Intel® Ethernet Network Adapter for OCP* Support | Onboard Video | Onboard System Fan | EVAC Heat Sink Support |
|--------------------------|------------------|-----------------|------------------|---------------------------|---------------------|--------------------------------|--|---------------|--------------------|------------------------|
| M50CYP2SB1U              | 2                | 32              | 3                | 8                         | 8                   | Opt                            | Opt  | Yes           | 8                  | Yes                    |
| M50CYP2SBSTD             | 2                | 32              | 3                | 8                         | 8                   | Opt                            | Opt  | Yes           | 6                  | No                     |

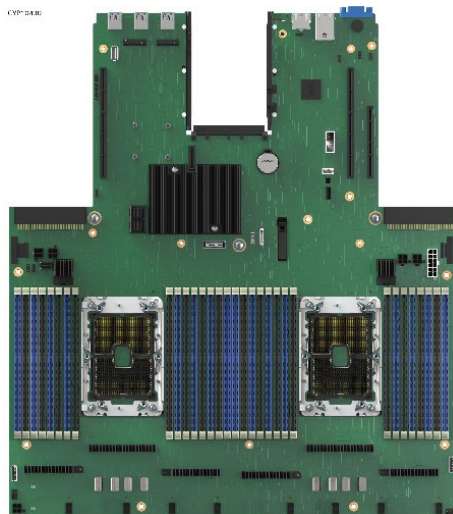
**Table 8. Server System (L6 BIK) Family Summary**

| Intel Product Code (iPC) | Chassis Form Factor | Server Board Option | Drive Form Factor | # of Drives (front) | 2.5" NVMe* Support | # of SSD Drives (internal fixed) | # of PCIe* Add-in Card Slots | Power Supply Modules | Rails | SAS RAID      | SAS Expander  | Memory Included | Processor Included |
|--------------------------|---------------------|---------------------|-------------------|---------------------|--------------------|----------------------------------|------------------------------|----------------------|-------|---------------|---------------|-----------------|--------------------|
| M50CYP1UR212             | 1U                  | M50CYP2SB1U         | 2.5"              | 12                  | Opt (up to 12)     | N/A                              | 3                            | Opt (up to 2)        | Opt   | Opt (up to 1) | Opt (up to 1) | No              | No                 |
| M50CYP1UR204             | 1U                  | M50CYP2SB1U         | 2.5"              | 4                   | Opt (up to 4)      | N/A                              | 3                            | Opt (up to 2)        | Opt   | Opt (up to 1) | Opt (up to 1) | No              | No                 |
| M50CYP2UR208             | 2U                  | M50CYP2SBSTD        | 2.5"              | 8, 16, 24           | Opt (up to 24)     | Opt (up to 2)                    | 8                            | Opt (up to 2)        | Opt   | Opt (up to 1) | Opt (up to 1) | No              | No                 |
| M50CYP2UR312             | 2U                  | M50CYP2SBSTD        | 3.5"              | 12                  | Opt (up to 4)      | Opt (up to 2)                    | 8                            | Opt (up to 2)        | Opt   | Opt (up to 1) | Opt (up to 1) | No              | No                 |

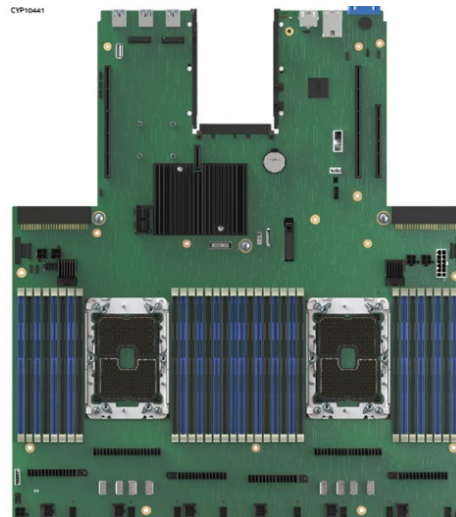
## 2. Server Board Options

Server board options are offered to create a custom system configuration from the board up. Each building block component and optional accessory is purchased separately and assembled by a system integrator. At a minimum, a base functional server system using building blocks requires the following:

- Server Chassis (Not sold by Intel)
- Intel® Server Board M50CYP2SB1U or M50CYP2SBSTD option
- Power supply module(s)
- SATA/NVMe\* data cables
- Power cord(s)
- Rack mount kit – rails or fixed mount
- Processor
- Memory
- Storage devices



Intel® Server Board M50CYP2SB1U



Intel® Server Board M50CYP2SBSTD



Power supply modules



PCIe\* riser cards

**Figure 15. Illustration of Building Block Options**

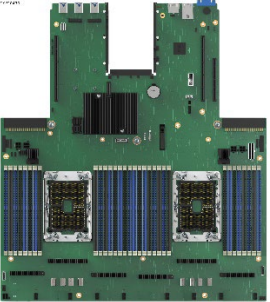
Optional Intel accessories that can be added include the following:

- PCIe\* riser card options
- Intel® SAS/SAS RAID support – PCIe\* add-in card and appropriate SAS data cable(s)
- Intel® Ethernet Network Adapter for OCP\* - to add additional features without losing a PCIe\* add-in slot

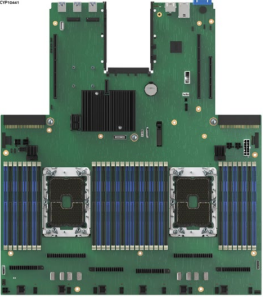
See [Chapter 5](#) for all available options.

## 2.1 Intel® Server Board M50CYP2SB Family Options

**Table 9. Intel® Server Board M50CYP2SB Family Options**

| Product Image   | Details   | Description   |
|---|---|---|
|  | <p><b>Intel® Server Board M50CYP2SB1U</b></p> <p><b>iPC</b> M50CYP2SB1U<br/> <b>MM#</b> 99A3TR<br/> <b>UPC</b> 00735858471671<br/> <b>EAN</b> 5032037210119<br/> <b>MOQ</b> 1</p> <p><b>Product type</b> Server board only<br/>           Building block/spare FRU</p> <p><b>Packaged gross wt.</b> 9.24 lbs.<br/> <b>Un-packaged net wt.</b> 4.95 lbs. (1 board)</p> | <p>See <a href="#">Table 4</a> for the complete feature set. Unique board features include:</p> <ul style="list-style-type: none"> <li>• (8) – Server board SlimSAS connectors, four per processor</li> <li>• (10) – SATA 6 Gbps ports including two M.2 SSD ports</li> <li>• Fans               <ul style="list-style-type: none"> <li>- Eight 8-pin fan connectors</li> <li>- CPU fan headers (one for each CPU)</li> </ul> </li> <li>• 32 DIMM slots, 16 per processor</li> <li>• Support for Intel® Optane™ persistent memory 200 series</li> <li>• Intel® C621A chipset</li> <li>• Support for EVAC heat sink</li> </ul> <p><b>Box includes:</b> (1) server board</p> <hr/> <p><b>Note:</b> All necessary mounting hardware, cabling, and shielding ship with the chassis and optional accessory kits.</p> |

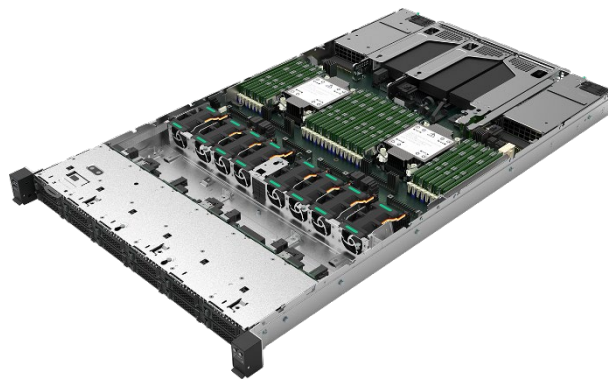


| Product Image   | Details   | Description  |
|---|---|--|
|  | <p><b>Intel® Server Board M50CYP2SBSTD</b></p> <p><b>iPC</b> M50CYP2SBSTD<br/> <b>MM#</b> 99A5A0<br/> <b>UPC</b> 00735858471664<br/> <b>EAN</b> 5032037210102<br/> <b>MOQ</b> 1</p> <p><b>Product type</b> Server board only<br/> Building block/spare FRU</p> <p><b>Packaged gross wt.</b> 40.2 lbs.<br/> <b>Un-packaged net wt.</b> 24.75 lbs. (5 boards)</p> | <p>See <a href="#">Table 5</a> for the complete feature set. Unique board features include:</p> <ul style="list-style-type: none"> <li>• (8) – Server board SlimSAS connectors, four per processor</li> <li>• (10) – SATA 6 Gbps ports including two M.2 SSD ports</li> <li>• Fans <ul style="list-style-type: none"> <li>- Six 6-pin fan connectors</li> <li>- Eight 8-pin fan connectors</li> <li>- CPU fan headers (one for each CPU)</li> </ul> </li> <li>• 32 DIMM slots, 16 per processor</li> <li>• Support for Intel® Optane™ persistent memory 200 series</li> <li>• Intel® C621A chipset</li> </ul> <p><b>Box includes:</b> (5) server boards</p> <hr/> <p><b>Note:</b> All necessary mounting hardware, cabling, and shielding ship with the chassis and optional accessory kits.</p> <hr/> |

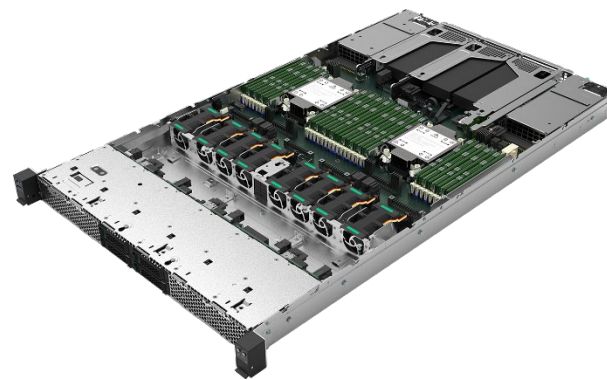
### 3. Server System Configurations

The Intel® Server M50CYP family includes several integrated server system options that include a 1U or 2U chassis with different hot swap drive bay configurations and a specific server board. At a minimum, building a functional server from one of these options requires the following:

- Rack mount kit – rails or fixed mount
- Power supply unit with power cords
- Processor(s)
- Memory
- Storage drives

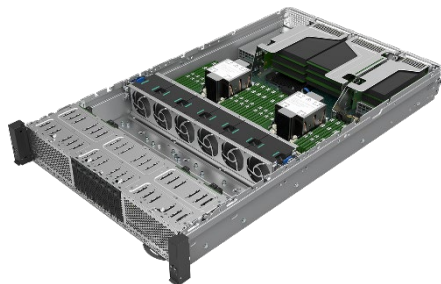


M50CYP1UR212

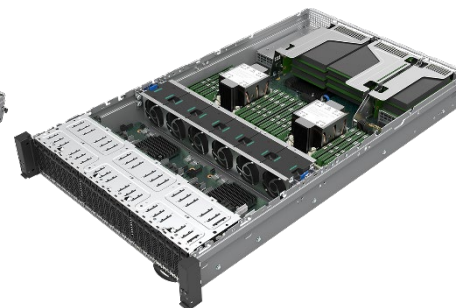


M50CYP1UR204

**Figure 16. Intel® Server System M50CYP1UR Family Options**



M50CYP2UR208

x16 Front Drive Bay System based on  
M50CYP2UR208x24 Front Drive Bay System based on  
M50CYP2UR208

M50CYP2UR312

**Figure 17. Intel® Server System M50CYP2UR Family Options**

Optional Intel accessories that can be added include:

- Second power supply module to add power redundancy
- Intel® RAID support – PCIe\* add-in card or module and appropriate SAS data cable(s)
- Intel® RAID Maintenance Free Backup unit – Intel RAID backup accessory
- Intel® Ethernet Network Adapter for OCP\* modules

See [Chapter 5](#) and [Chapter 6](#) for a full list of available options.

### 3.1 Intel® Server System M50CYP1UR Family – (1U Rack Mount System)

The product tables found in this section provide order code information and detailed descriptions for each available 1U L6 Intel Server System option. The lower sections of each table identify:

- **Included** – The ship along components of the specified chassis product code (product BOM).
- **Required items** – Hardware required to be installed to the base system to achieve basic functionality using the default system feature set. Required items are sold separately.
- **Optional accessories** – Some of the available accessories that can be installed to enhance the basic feature set of the server board/chassis. Optional accessories are sold separately. Additional accessories are in [Chapter 5](#).

---


**Note:** Items identified with an iPC (Intel Product Code) are orderable building block options, accessories, or spare Field Replaceable Units (FRUs). To provide the complete product bill of materials, the ship along components list in each product table include items identified by description and by iPN (Intel Part Number). The iPN information is provided for reference only. These components are not orderable as spares or accessories.

---


This product family offers two levels of server system integration:

- **L6** – Integrated system: Chassis and server board, with no processors, memory, or storage devices.

**Table 10. Intel® Server System M50CYP1UR204 product Specifications and Configuration Requirements**

| Intel® Server System M50CYP1UR204   |  |   |
|---|--|---|
| 1U, Intel® Server Board M50CYP2SB1U, 4 x 2.5" SAS/SATA/NVMe SSD front mount drive bays  |  |   |
|    | <p><b>iPC</b> M50CYP1UR204<br/> <b>MM#</b> 99A3TX<br/> <b>UPC</b> 00735858481793<br/> <b>EAN</b> 5032037219013<br/> <b>MOQ</b> 1</p>   | <p><b>Product type</b> L6 integrated system<br/> <b>Chassis form factor</b> 1U rack mount<br/> <b>Packaged gross wt.</b> 21.15 kg<br/> <b>Un-packaged net wt.</b> 14.18 kg<br/> <b>Chassis dimensions</b> 781 x 438 x 43 mm (L x W x H)<br/> <b>Package dimensions (outer box)</b> 994 x 592 x 300 mm (L x W x H)</p>   |
| Included  | Required Items (sold separately)   | Optional Accessories (sold separately)  |
| <p>(1) – 1U 2.5" Chassis with quick reference label affixed to top cover – iPN <b>K52548-xxx</b></p> <ul style="list-style-type: none"> <li>○ (1) – Quick reference label – iPN <b>M24177-xxx</b></li> </ul> <p>(4) – Hot-swap drive bays with drive mounting rails and blanks – iPN <b>K53035-xxx</b></p> <ul style="list-style-type: none"> <li>○ 2.5" SSD mounting rail with extraction lever – iPN <b>K71493-xxx</b></li> <li>○ 2.5" SSD Blank – iPN <b>K71491-xxx</b></li> </ul> <p>(1) – Front USB panel (left) with two USB ports – iPN <b>K48177-xxx</b></p> <ul style="list-style-type: none"> <li>○ (1) – <b>601 mm</b> USB 3.0/2.0 cable from server board to panel – iPN <b>K67061-xxx</b></li> </ul> <p>(1) – Front control panel (right) with control/status buttons – iPN <b>K48178-xxx</b></p> <ul style="list-style-type: none"> <li>○ (1) – <b>597.5 mm</b> front panel cable 26 pin – iPN <b>K67060-xxx</b></li> </ul> <p>(1) – 1U Server board – iPC <b>M50CYP2SB1U</b><br/> (1) – 4 x 2.5" Combo HSBP – iPC <b>CYPHSBP1204</b><br/> (1) – Cable wall Assembly (Left) – iPN <b>K72602-xxx</b><br/> (1) – Cable wall Assembly (Right) – iPN <b>K72603-xxx</b><br/> (1) – 1 Slot x16 LP PCIe* riser card for Riser Slot #1 – iPC <b>CYP1URISER1STD</b><br/> (16) – DIMM Blank – iPN <b>K91058-xxx</b><br/> (1) – <b>445/720 mm</b> splitter power cable from server board to HSBP – iPN <b>K61358-xxx</b><br/> (1) – <b>350 mm</b> I<sup>2</sup>C cable from server board to HSBP – iPN <b>K63232-xxx</b><br/> (2) – EVAC heat sink – iPC <b>K67428-xxx</b><br/> (8) – Dual-rotor system fan – iPC <b>CYPFAN1UKIT</b><br/> (2) – Processor carrier clip – iPN <b>J98484-xxx</b><br/> (1) – Intel® RAID Maintenance Free Backup Unit (RMFBU) bracket</p> | <ul style="list-style-type: none"> <li>• (1) or (2) Power Supply Unit(s), 1300 W, 1600 W – See <a href="#">Section 5.4</a></li> <li>• Power cord(s) – See <a href="#">Section 5.4</a></li> <li>• Rack mount kit – See <a href="#">Section 5.5</a></li> <li>• (1) or (2) 3<sup>rd</sup> Gen Intel® Xeon® Scalable processor</li> <li>• ECC DDR4 memory (RDIMM, LRDIMM, 3DS-RDIMM, or 3DS-LRDIMM)</li> </ul> | <p>The following is a partial list of supported accessories. See <a href="#">Chapters 5</a> and <a href="#">6</a> for all available accessory options.</p> <ul style="list-style-type: none"> <li>• Second AC power supply module to support power redundancy (1300 W (iPC <b>AXX1300TCRPS</b>) / 1600 W (iPC <b>AXX1600TCRPS</b>))</li> <li>• Intel® Ethernet Network Adapter for OCP* - See <a href="#">Section 5.2</a> for available options</li> <li>• Intel® 12G SAS RAID module and Intel® RAID Maintenance Free Backup unit - See <a href="#">Section 5.3</a> for available options</li> <li>• NVMe* data cable kit: – iPC <b>CYPCBLSL104KIT</b></li> <li>• SAS/SATA/NVMe* – Cable selection is dependent on storage options. See <a href="#">Chapter 4</a> for available cable options</li> <li>• Standard Intel® VROC 7.5 Key – iPC <b>VROCSTANMOD</b></li> <li>• Storage drives</li> <li>• DDR4-compatible Intel® Optane™ persistent memory 200 series module (requires an installed 3<sup>rd</sup> Gen Intel® Xeon® Scalable processor)</li> </ul> |

**Table 11. Intel® Server System M50CYP1UR212 Specifications and Configuration Requirements**

| Intel® Server System M50CYP1UR212  |  |  |  |
|--|--|--|--|
| 1U, Intel® Server Board M50CYP2SB1U, 12 x 2.5" SAS/SATA/NVMe SSD front mount drive bays  |  |  |  |
|   | <p><b>iPC</b> M50CYP1UR212<br/> <b>MM#</b> 99A3TW<br/> <b>UPC</b> 00735858481786<br/> <b>EAN</b> 5032037219006<br/> <b>MOQ</b> 1</p>   | <p><b>Product type</b> L6 integrated system<br/> <b>Chassis form factor</b> 1U rack mount<br/> <b>Packaged gross wt.</b> 21.55 Kg<br/> <b>Un-packaged net wt.</b> 14.58 Kg<br/> <b>Chassis dimensions</b> 781 x 438 x 43 mm (L x W x H)<br/> <b>Package dimensions</b> 994 x 592 x 300 mm (L x W x H)</p>  |  |
| Included   | Required Items (sold separately)   | Optional Accessories (sold separately)   |  |
| <p>(1) – 1U 2.5" Chassis with quick reference label affixed to top cover – iPN <b>K52548-xxx</b></p> <ul style="list-style-type: none"> <li>○ (1) – Quick reference label – <b>M24177_001</b></li> </ul> <p>(12) – Hot-swap drive bays with drive mounting rails and blanks – iPN <b>K53035-xxx</b></p> <ul style="list-style-type: none"> <li>○ 2.5" SSD mounting rail with extraction lever – iPN <b>K71493-xxx</b></li> <li>○ 2.5" SSD Blank – iPN <b>K71491-xxx</b></li> </ul> <p>(1) – Front USB panel (Left) with two USB ports – iPN <b>K48177-xxx</b></p> <ul style="list-style-type: none"> <li>○ (1) – <b>601 mm</b> USB 3.0/2.0 cable from server board to panel – iPN <b>K67061-xxx</b></li> </ul> <p>(1) – Front control panel (right) with control/status buttons – iPN <b>K48178-xxx</b></p> <ul style="list-style-type: none"> <li>○ (1) – <b>597.5 mm</b> front panel cable 26 pin – iPN <b>K67060-xxx</b></li> </ul> <p>(1) – 1U Server board – iPC <b>M50CYP2SB1U</b></p> <p>(1) – 12 x 2.5" Combo HSBP – iPC <b>CYPHSBP1212</b></p> <p>(1) – Cable wall Assembly (Left) – iPN <b>K72602-xxx</b></p> <p>(1) – Cable wall Assembly (Right) – iPN <b>K72603-xxx</b></p> <p>(1) – 1 Slot x16 LP PCIe* riser card for Riser Slot #1 – iPC <b>CYP1URISER1STD</b></p> <p>(16) – DIMM Blank – iPN <b>K91058-xxx</b></p> <p>(1) – <b>445/720 mm</b> splitter power cable from server board to HSBP – iPN <b>K61358-xxx</b></p> <p>(1) – <b>250 mm</b> I<sup>2</sup>C cable from server board to HSBP iPN <b>K63231-xxx</b></p> <p>(2) – Standard 1U heat sink – iPC <b>K39908-xxx</b></p> <p>(8) – Dual-rotor system fan – iPC <b>CYPFAN1UKIT</b></p> <p>(2) – Processor Carrier Clip – iPN <b>J98484-xxx</b></p> <p>(1) – Intel® RAID Maintenance Free Backup Unit (RMFBU) bracket</p> | <ul style="list-style-type: none"> <li>• (1) or (2) Power Supply Unit(s), 1300 W, 1600 W – See <a href="#">Section 5.4</a></li> <li>• Power cord(s) – See <a href="#">Section 5.4</a></li> <li>• Rack mount kit – See <a href="#">Section 5.5</a></li> <li>• (1) or (2) 3<sup>rd</sup> Gen Intel® Xeon® Scalable processor</li> <li>• ECC DDR4 memory (RDIMM, LRDIMM, 3DS-RDIMM, or 3DS-LRDIMM)</li> </ul> | <p>The following is a partial list of supported accessories. See <a href="#">Chapters 5</a> and <a href="#">6</a> for all available accessory options.</p> <ul style="list-style-type: none"> <li>• Second AC power supply unit to support power redundancy (1300 W PSU – iPC <b>AXX1300TCRPS</b>; 1600 W PSU – iPC <b>AXX1600TCRPS</b>)</li> <li>• Intel® Ethernet Network Adapter for OCP* - See <a href="#">Section 5.2</a> for available options</li> <li>• Intel® 12G SAS RAID module and Intel® RAID Maintenance Free Backup unit - See <a href="#">Section 5.3</a> for available options</li> <li>• SAS/SATA/NVMe* – Cable selection is dependent on storage options. See <a href="#">Chapter 4</a> for available cable options.</li> <li>• NVMe* data cable kit: – iPC <b>CYPCBLSL112KIT</b></li> <li>• Standard Intel® VROC 7.5 Key – iPC <b>VROCSTANMOD</b></li> <li>• Storage drives</li> <li>• DDR4-compatible Intel® Optane™ persistent memory 200 series module (requires an installed 3<sup>rd</sup> Gen Intel® Xeon® Scalable processor)</li> <li>• Slot PCIe* NVMe* riser card for Riser Slot #3 – iPC <b>CYPRISER3RTM</b></li> </ul> |  |

## 3.2 Intel® Server System M50CYP2UR Family – (2U Rack Mount System)

The product tables found in this section provide order code information and detailed descriptions for the specified L6 Integrated 2U Intel® Server System. The lower sections of each table identify:


- **Included** – The ship along components of the specified chassis product code – (product BOM)
- **Required Items** – The options required to be installed to the base system to achieve basic functionality using the default system feature set
- **Optional Accessories** – Some of the available accessories that can be installed to enhance the basic feature set of the server board / chassis. Additional accessories are in [Chapter 4](#).

---


**Notes:**

- Each required item and optional accessory are sold separately for the specified Intel L6 server system.
  - Items identified as iPC (Intel Product Code) are an orderable building block option, accessory, or spare FRU.
  - To provide the complete product bill of materials, the ship along components list in each product table will include items identified by description and by iPN (Intel Part Number). The iPN information is provided for reference only. These components are not orderable as a spare or accessory.
  - L6 – Integrated system: Chassis and server board, with no processors, memory, or storage devices.
-

**Table 12. Intel® Server System M50CYP2UR208 product Specifications and Configuration Requirements**

| <b>Intel® Server System M50CYP2UR208</b><br>2U, Intel® Server Board M50CYP2SBSTD, 8 x 2.5" SSD SAS/SATA front mount drives  |   |   |
|---|---|---|
|    | <b>iPC</b> M50CYP2UR208<br><b>MM#</b> 99A3TT<br><b>UPC</b> 00735858481762<br><b>EAN</b> 5032037218986<br><b>MOQ</b> 1   | <b>Product type</b> L6 integrated system<br><b>Chassis form factor</b> 2U rack mount<br><b>Packaged gross wt.</b> 24.36Kg<br><b>Un-packaged net wt.</b> 16.76Kg<br><b>Chassis dimensions</b> 770 x 446 x 87 mm (L x W x H)<br><b>Package dimensions</b> 994 x 592 x 300 mm (L x W x H)  |
| Included  | Required Items (sold separately)  | Optional Accessories (sold separately)  |
| <p>(1) – 2U 2.5" Chassis with Quick Reference Label affixed to top cover – iPN <b>K52544-xxx</b></p> <ul style="list-style-type: none"> <li>○ (1) – Quick reference label – iPN <b>M24213-xxx</b></li> </ul> <p>(8) – 2.5" hot-swap drive bays with drive mounting rails and blanks – iPN <b>K53035-xxx</b>. Includes:</p> <ul style="list-style-type: none"> <li>○ 2.5" SSD mounting rail with lever – iPN <b>K71493-xxx</b></li> <li>○ 2.5" SSD Blank – iPN <b>K71491-xxx</b></li> </ul> <p>(1) – Front I/O assembly w/ two USB ports, left side – iPN <b>K48177-xxx</b></p> <ul style="list-style-type: none"> <li>○ <b>601 mm</b> USB 3.0/2.0 cable, server board to front I/O assembly, – iPN <b>K67061-xxx</b></li> </ul> <p>(1) – Front control panel (right) with control/status buttons – iPN <b>K48178-xxx</b></p> <ul style="list-style-type: none"> <li>○ (1) – <b>598.5 mm</b> front panel cable, 26 pin – iPN <b>K67059-xxx</b></li> </ul> <p>(1) – 2U Server Board – iPC <b>M50CYP2SBSTD</b></p> <p>(1) – 8 x 2.5" Combo HSBP – iPC <b>CYPHSBP2208</b></p> <p>(16) – DIMM blanks – iPN <b>K91058-xxx</b></p> <p>(1) – <b>455/565/720 mm</b> splitter power cable, server board to HSBPs (1, 2, and 3) 2x6 pin to three 2x2 pin – iPN <b>K62572-xxx</b></p> <p>(1) – <b>350 mm</b> I<sup>2</sup>C cable, server board to HSBP– iPN <b>K63232-xxx</b></p> <p>(1) – Standard 2U air duct (for 2U-Tall HS) – iPN <b>K52571-xxx</b></p> <p>(6) – Single-rotor system fan – iPC <b>CYPFAN2UKIT</b></p> <p>(2) – Processor carrier clip – iPN <b>J98484-xxx</b></p> <p>(2) – Intel® RAID Maintenance Free Backup Unit (RMFBU) bracket</p> | <ul style="list-style-type: none"> <li>• (1) or (2) Power Supply Unit(s), 1300 W, 1600 W, or 2100 W – See <a href="#">Section 5.4</a></li> <li>• Power cord(s) – See <a href="#">Section 5.4</a></li> <li>• Rack mount kit – See <a href="#">Section 5.5</a></li> <li>• (1) or (2) 3<sup>rd</sup> Gen Intel® Xeon® processor Scalable family</li> <li>• ECC DDR4 memory (RDIMM, LRDIMM, 3DS-RDIMM, or 3DS-LRDIMM)</li> <li>• (1) or (2) Standard 1U or 2U heat sink– See <a href="#">Chapter 6</a></li> </ul> | <p>The following is a partial list of supported accessories. See <a href="#">Chapters 5 and 6</a> for all available accessory options.</p> <ul style="list-style-type: none"> <li>• Second AC power supply unit to support power redundancy (1300 W PSU - iPC <b>AXX1300TCRPS</b>; 1600 W PSU - iPC <b>AXX1600TCRPS</b>, 2100 W - iPC <b>FCXX2100CRPS</b>)</li> <li>• Intel® Ethernet Network Adapter for OCP* - See <a href="#">Section 5.2</a> for available options</li> <li>• Intel® 12G SAS RAID module and Intel® RAID Maintenance Free Backup unit. See <a href="#">Chapter 5.3</a> for available options</li> <li>• SAS Data cable kits– iPC <b>CYPCBLSLINTKIT</b> and <b>CYPCBLHDHDXXX2</b></li> <li>• SAS/SATA/NVMe* – Cable selection is dependent on storage options. See <a href="#">Chapter 4</a> for available cable options.</li> <li>• Standard Intel® VROC 7.5 Key– iPC <b>VROCSTANMOD</b></li> <li>• Storage drives</li> <li>• DDR4-compatible Intel® Optane™ persistent memory 200 series module (requires an installed 3<sup>rd</sup> Gen Intel® Xeon® Scalable processor)</li> <li>• Slot PCIe* NVMe* riser card for Riser Slot #3 – iPC <b>CYPRISER3RTM</b></li> </ul> |

**Table 13. Intel® Server System M50CYP2UR312 Product Specifications and Configuration Requirements**

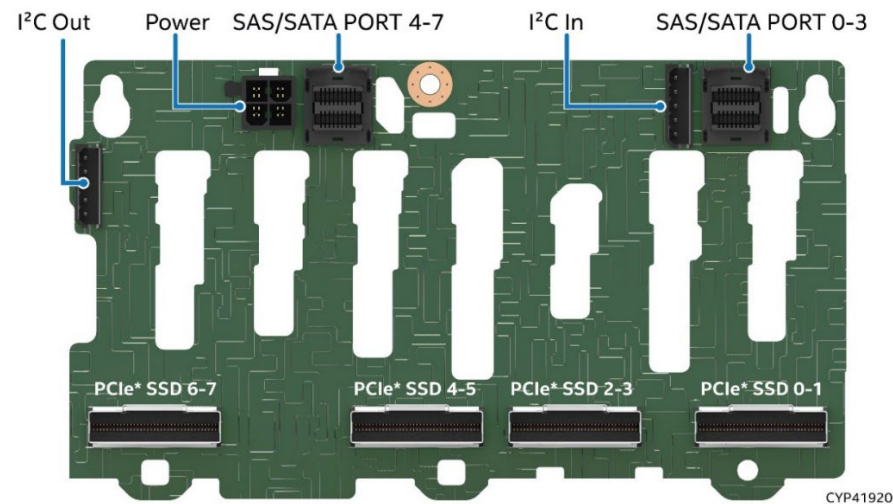
| Intel® Server System M50CYP2UR312  |  |  |  |
|--|--|--|--|
| 2U, Intel® Server Board M50CYP2SBSTD, 12 x 3.5" SAS/SATA /NVMe* front mount drives   |  |  |  |
|   |  | <b>iPC</b> M50CYP2UR312<br><b>MM#</b> 99A3TV<br><b>UPC</b> 00735858481779<br><b>EAN</b> 5032037218993<br><b>MOQ</b> 1  | <b>Product type</b> L6 integrated system<br><b>Chassis form factor</b> 2U rack mount<br><b>Packaged gross wt.</b> 25.46Kg<br><b>Un-packaged net wt.</b> 17.86Kg<br><b>Chassis dimensions</b> 712 x 439 x 89 mm (L x W x H)<br><b>Package dimensions</b> 983 x 577 x 260 mm (L x W x H) |
| Included   | Required Items (sold separately)   | Optional Accessories (sold separately)   |  |
| (1) – Chassis with Quick Reference Label affixed to top cover – iPN <b>K52545-xxx</b> <ul style="list-style-type: none"> <li>○ (1) – Quick reference label – iPN <b>M24213-xxx</b></li> </ul> (1) – 2U 3.5" Chassis – iPN <b>K52545-xxx</b><br>(1) – Front I/O assembly w/ two USB ports, left side – iPN <b>K48177-xxx</b> <ul style="list-style-type: none"> <li>○ (1) <b>601 mm</b> USB 3.0/2.0 cable, server board to front I/O assembly, – iPN <b>K67061-xxx</b></li> </ul> (1) – Front control panel (right) with control/status buttons – iPN <b>K48178-xxx</b> <ul style="list-style-type: none"> <li>○ (1) <b>598.5 mm</b> front control panel cable, 26 pin – iPN <b>K67059-xxx</b></li> </ul> (1) – 2U Server Board – iPC <b>M50CYP2SBSTD</b><br>(1) – 12 x 3.5 Combo HSBP – iPC <b>CYPHSBP2312</b><br>(12) – 3.5" HDD/SSD drive carriers 3.5" – iPN <b>J36447-xxx</b><br>(16) – DIMM Blank – iPN <b>K91058-xxx</b><br>(1) – <b>425/660 mm</b> splitter power cable, server board connector to 3.5" HSBP power connectors – iPN <b>K67596-xxx</b><br>(1) – <b>250 mm</b> I <sup>2</sup> C cable, server board to HSBP – iPN <b>K63231-xxx</b><br>(1) – Standard air duct for 2U – iPN <b>K52571-xxx</b><br>(6) – Single-rotor system fan – iPC <b>CYPFAN2UKIT</b><br>(2) – Processor carrier clip – iPN <b>J98484-xxx</b><br>(2) – Intel® RAID Maintenance Free Backup Unit (RMFBU) bracket | <ul style="list-style-type: none"> <li>• (1) or (2) Power Supply Unit(s), 1300 W, 1600 W, or 2100 W – See <a href="#">Section 5.4</a></li> <li>• Power cord(s) – See <a href="#">Section 5.4</a></li> <li>• Rack mount kit – See <a href="#">Section 5.5</a></li> <li>• (1) or (2) 3<sup>rd</sup> Gen Intel® Xeon® processor Scalable family</li> <li>• ECC DDR4 memory (RDIMM, LRDIMM, 3DS-RDIMM, or 3DS-LRDIMM)</li> <li>• (1) or (2) Standard 1U or 2U heat sink – See <a href="#">Chapter 6</a></li> </ul> | The following is a partial list of supported accessories. See <a href="#">Chapters 5 and 6</a> for all available accessory options. <ul style="list-style-type: none"> <li>• Second AC power supply unit to support power redundancy (1300 W PSU - iPC <b>AXX1300TCRPS</b>; 1600 W PSU - iPC <b>AXX1600TCRPS</b>, 2100 - iPC <b>FCXX2100CRPS</b>)</li> <li>• Intel® Ethernet Network Adapter for OCP. See <a href="#">Section 5.2</a> for available options</li> <li>• Intel® 12G SAS RAID module and Intel® RAID Maintenance Free Backup unit. See <a href="#">Section 5.3</a> for available options</li> <li>• SAS Data cable kits – iPC <b>CYPCBLSLINTKIT</b> and <b>CYPCBLHDHDXXX2</b></li> <li>• SAS/SATA/NVMe* – Cable selection is dependent on storage options. See <a href="#">Chapter 4</a> for available cable options.</li> <li>• Standard Intel® VROC 7.5 Key – iPC – <b>VROCSTANMOD</b></li> <li>• Storage drives</li> <li>• DDR4-compatible Intel® Optane™ persistent memory 200 series module (requires an installed 3<sup>rd</sup> Gen Intel® Xeon® Scalable processor)</li> <li>• 2-Slot PCIe* NVMe* riser card for Riser Slot #3 – iPC <b>CYPRISER3RTM</b></li> </ul> |  |



## 4. SAS / SATA / NVMe\* Data Cable Guide

SAS/SATA/NVMe\* data cables are not included with any of the L3 or L6 SKUs. They must be ordered separately to match the desired system configuration.

Images from [Figure 18](#) through [Figure 21](#) show the back side of the 1U and 2U backplane options. The backside of each installed backplane has a four-port SFF-8643 Mini-SAS HD data connector for each set of four SAS/SATA drives. Each port supports one SAS/SATA drive. The back side of each backplane also includes PCIe\* NVMe\* SlimSAS connectors to support PCIe\* NVMe\* drives. Drive numbers in the cable configuration tables match the specific cable connectors found on the given backplane.



**Figure 18. 2U 8 x 2.5" SAS / SATA / NVMe\* Hot-Swap Backplane – Back Side**

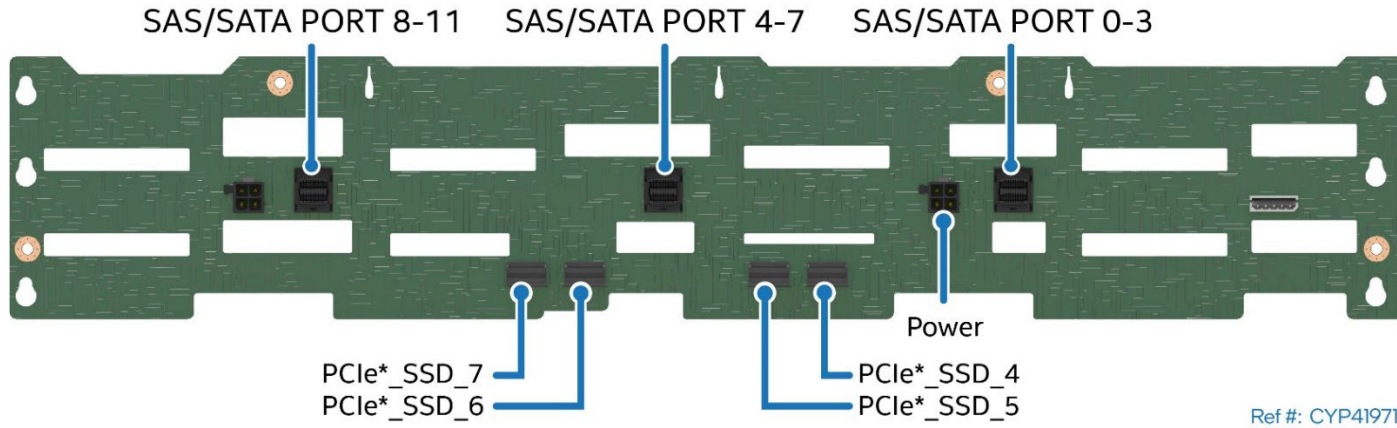


Figure 19. 2U 12 x 3.5" HSBP Connector Identification – Back Side

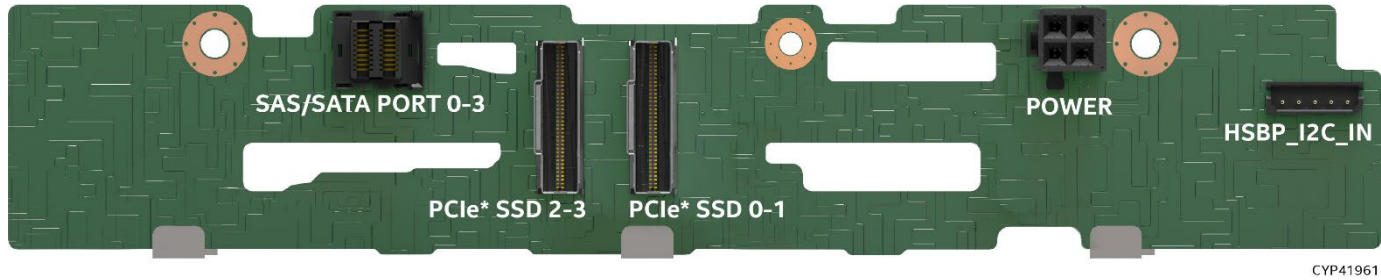


Figure 20. 1U 4 x 2.5" SAS / SATA / NVMe\* Hot Swap Backplane – Back Side

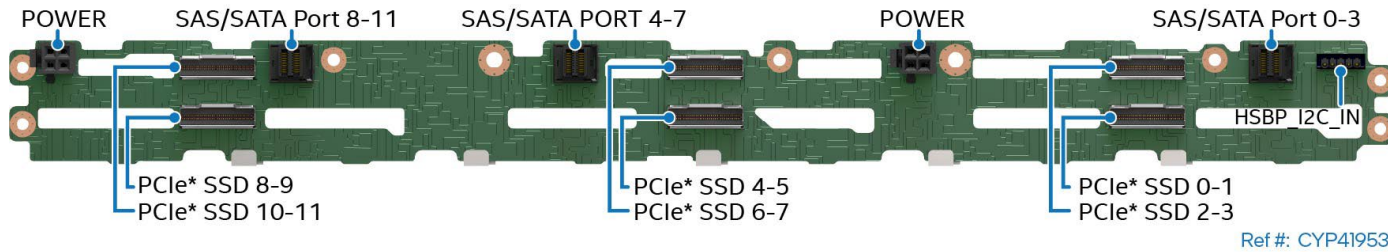



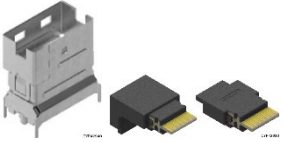
Figure 21. 1U 12 x 2.5" SAS / SATA / NVMe\* Hot Swap Backplane – Back Side

## 4.1 Data Cable Connector Types

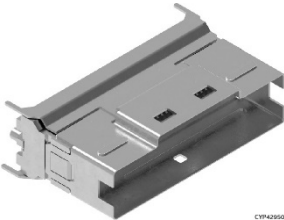
**Table 14. Multiport Mini SAS HD Cable Connectors**

| Image   | Description   |
|---|---|
|  | <p><b>SFF-8643 (mini SAS HD)</b><br/>                     Support for up to 12 Gb/Sec SAS<br/>                     Where it is used:</p> <ul style="list-style-type: none"> <li>• On the server board – (2) 4-port SATA connectors (SATA 0–3 &amp; SATA 4–7)</li> <li>• All 12 Gb/sec SAS capable hot swap backplanes</li> <li>• All 12 Gb/sec SAS RAID Controllers</li> <li>• 12 Gb/sec SAS Expander Card</li> </ul> |

**Table 15. x4 PCIe\* SlimSAS Cable Connectors**

| Image   | Description   |
|---|---|
|  | <p><b>x4 SlimSAS connectors</b><br/>                     Support for PCIe* NVMe* SFF (2.5") SSDs<br/>                     Where it is used:</p> <ul style="list-style-type: none"> <li>• On the server board – 8 connectors (4 per processor)</li> <li>• On 2U 3.5" SAS/SATA/NVMe* backplane</li> </ul> |

**Table 16. x8 PCIe\* SlimSAS Cable Connectors**

| Image   | Description   |
|---|---|
|  | <p><b>x8 SlimSAS connector</b><br/>                     Support for PCIe* NVMe* SFF (2.5") SSDs<br/>                     Where it is used:</p> <p><b>HSBP Options:</b></p> <ul style="list-style-type: none"> <li>• 4 x 2.5" SAS/SATA/NVMe* hot swap backplane</li> <li>• 12 x 2.5" SAS/SATA/NVMe* hot swap backplane</li> <li>• 8 x 2.5" Drive SAS/SATA/NVMe* Combo backplane</li> </ul> <p><b>Riser Card Options:</b></p> <ul style="list-style-type: none"> <li>• Interposer riser card option – iPC <b>CYP1URISER2KIT</b></li> <li>• 1U/2U PCIe* NVMe* riser card, Riser Slot #3 – iPC <b>CYPRISER3RTM</b></li> <li>• PCIe* NVMe* riser card for Riser Slot #1 – iPC <b>CYP2URISER3RTM</b></li> </ul> |

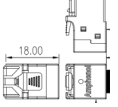

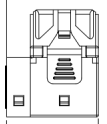
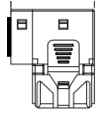


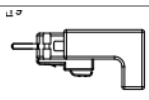
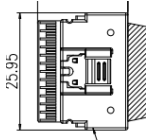
## 4.2 1U / 2U Server System SAS / SATA / NVMe\* Cable Kits

The following table identifies the different data cable connector types and the identifiers used in the cable kit product codes.

Product tables in this section reference specific SAS/SATA and NVMe cables. Different cable kits are offered to support specific system configurations. The product order code for each cable kit is made up of a string of letters and numbers to identify the type of cable included in the kit.

The following table identifies the different data cable connector types and the identifiers used in the cable kit product codes.

**Table 17. Data Cable Connector Identification**

| Connector Image   | Cable Connector Type | Description   |
|---|----------------------|---|
|    | RA<br>Mini-SAS HD    | Right angle SFF-8643 (mini SAS HD) connector          |
|    | VT<br>Mini-SAS HD    | Straight/Vertical SFF-8643 mini SAS HD connector      |
|    | RS<br>Mini-SAS HD    | Right side SFF-8643 mini SAS HD connector             |
|   | LS<br>Mini-SAS HD    | Left side SFF-8643 mini SAS HD connector              |
|  | VT<br>X4 SlimSAS     | Straight/Vertical X4 SlimSAS PCIe* NVMe* connector    |
|  | RA<br>X4 SlimSAS     | Right angle X4 SlimSAS PCIe* NVMe* connector          |
|  | RRA<br>X4 SlimSAS    | Reversed right angle X4 SlimSAS PCIe* NVMe* connector |
|  | VT<br>X8 SlimSAS     | X8 SlimSAS PCIe* NVMe* connector                      |

### 4.2.1 Cable Kit Product Code Decoder Examples

| Abbreviation | Description                       |
|--------------|-----------------------------------|
| <b>CBL</b>   | Cable                             |
| <b>COMM</b>  | Common Cables                     |
| <b>Kit</b>   | Data cable kit                    |
| <b>CYP</b>   | Intel Server System M50CYP Family |
| <b>INT</b>   | SAS Interposer                    |
| <b>RT</b>    | Riser with re-timer               |
| <b>HD</b>    | Mini-SAS HD Connector             |
| <b>SL</b>    | SlimSAS connector                 |

#### SAS/SATA Data Cable Example – iPC **CYPCBLHDHDXXX**

- **CYPCBL** – Identifies a M50CYP accessory cable kit
- **HD** – Identifies that both ends of the cable are Mini-SAS HD SFF-8643 type connector


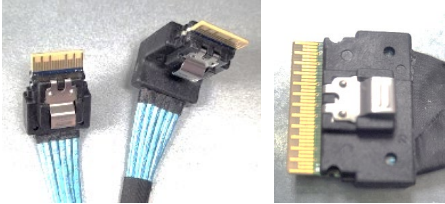
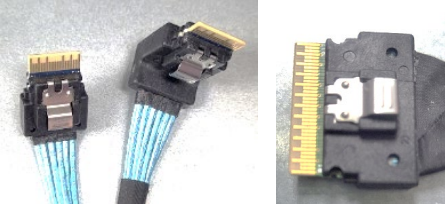
#### NVMe SlimSAS Cable Example – iPC **CYPCBLSL104KIT**

- **CYPCBL** – Identifies a M50CYP accessory cable kit
- **SL** – Identifies that both ends of cable have SlimSAS connector type
- **104** – Identifies that the cable kit is for 1U x4 front drive bay system

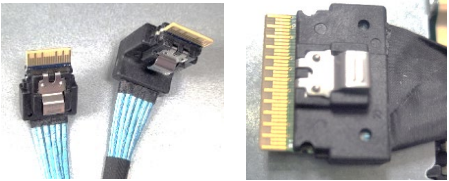


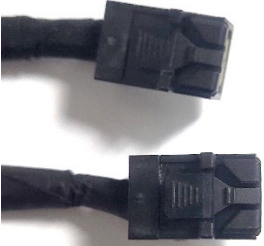
## 4.2.2 Cable Kit Order Information

**Note:** A splitter cable is a cable that has two or more connectors on one end.


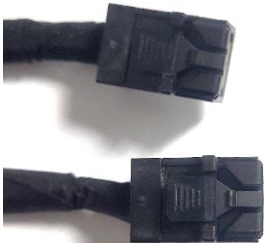

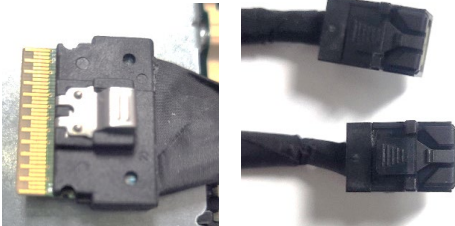
Table 18. SAS/SATA/NVMe\* Data Cable Kit Description and Order Information

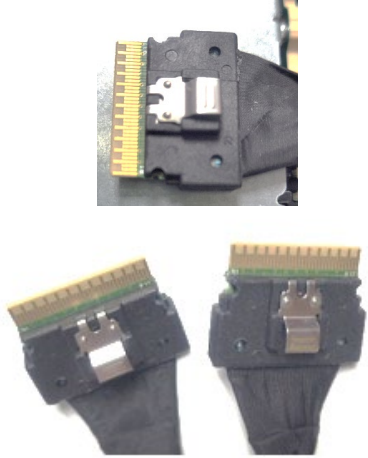
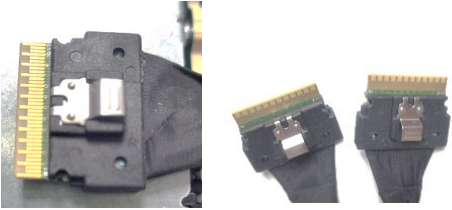
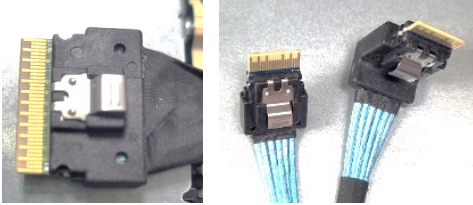
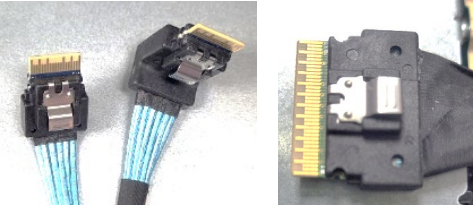
| Image   | Details  | Description  |
|---|--|--|
|    | <p><b>iPC</b> CYPBLSLINTKIT<br/> <b>MM#</b> 99AJF4<br/> <b>UPC</b> 00735858475129<br/> <b>EAN</b> 5032037213073<br/> <b>MOQ</b> 1</p>  | <p>Used in 1U / 2U systems as spare or accessory.</p> <p><b>Kit Includes:</b></p> <ul style="list-style-type: none"> <li>• (1) – <b>125/355 mm</b> splitter cable, Power cable connects server board 12 V power connector to Midplane card / Interposer card power connector.<br/> <b>Note:</b> System does not support both SAS Interposer card and Midplane card at the same time.</li> <li>• (1) – <b>610 mm</b> cable, I<sup>2</sup>C (P+S) server board (rear) to SAS Interposer card (10 Pin to 10 Pin)</li> <li>• (1) – <b>250 mm</b> cable, SB CPU0 x4 SlimSAS A or CPU1 x4 SlimSAS D to SAS Interposer card x4 SlimSAS A, VT -&gt; RA</li> <li>• (1) – <b>250 mm</b> cable, SB CPU0 x4 SlimSAS B or CPU1 x4 SlimSAS C to SAS Interposer card x4 SlimSAS B, RRA -&gt;RA</li> </ul> |
|   | <p><b>iPC</b> CYPBLSL208KIT<br/> <b>MM#</b> 99A5A3<br/> <b>UPC</b> 00735858475143<br/> <b>EAN</b> 5032037213097<br/> <b>MOQ</b> 1</p>  | <p>Used in 2U M50CYP2UR208 system to enable PCIe NVMe storage.</p> <p><b>Kit Includes:</b></p> <ul style="list-style-type: none"> <li>• (1) – <b>240/260 mm</b> splitter cable, connects server board CPU0 x4 SlimSAS A and B (VT) to HSBP x8 SlimSAS SSD0-1 (VT)</li> <li>• (1) – <b>330/310 mm</b> splitter cable, connects server board CPU0 x4 SlimSAS C and D (VT) to HSBP x8 SlimSAS SSD2-3 (VT)</li> <li>• (1) – <b>235/215 mm</b> splitter cable, connects server board CPU1 x4 SlimSAS C and D (VT) to HSBP x8 SlimSAS SSD6-7 (VT)</li> <li>• (1) – <b>370/390 mm</b> splitter cable, connects server board CPU1 x4 SlimSAS A and B (VT) to HSBP x8 SlimSAS SSD4-5 (VT)</li> </ul>  |
|  | <p><b>iPC</b> CYPBLSL216KIT<br/> <b>MM#</b> 99A5A4#<br/> <b>UPC</b> 00735858475150<br/> <b>EAN</b> 5032037213103<br/> <b>MOQ</b> 1</p> | <p>Used in 2U M50CYP2UR x16 front drive bay system to enable PCIe NVMe storage.</p> <p><b>Kit Includes:</b></p> <ul style="list-style-type: none"> <li>• (1)– <b>275/255 mm</b> splitter cable, connects server board CPU0 x4 SlimSAS C and D (VT) to HSBP (left) x8 SlimSAS SSD6-7 (VT)</li> <li>• (1)– <b>305/325 mm</b> splitter cable, connecting server board CPU0 x4 SlimSAS A and B (VT) to HSBP (left) x8 SlimSAS SSD4-5 (VT)</li> <li>• (1)– <b>360/340 mm</b> splitter cable, connects server board CPU1 x4 SlimSAS C and D (VT) to HSBP (right) x8 SlimSAS SSD14-15 (VT)</li> <li>• (1)– <b>240/260 mm</b> splitter cable, connects server board CPU1 x4 SlimSAS A and B (VT) to HSBP (right) x8 SlimSAS SSD12-13 (VT)</li> </ul>   |

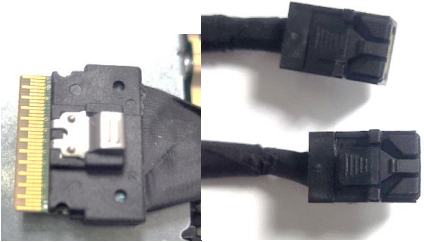
| Image   | Details  | Description   |
|---|--|---|
|    | <p><b>iPC</b> CYPBLSLMIDPIN<br/> <b>MM#</b> 99AJF6<br/> <b>UPC</b> 00735858475167<br/> <b>EAN</b> 5032037213110<br/> <b>MOQ</b> 1</p>  | <p>Used in 2U 2.5" systems with greater than 16 PCIe NVMe drives in the front bay.</p> <p><b>Kit Includes:</b></p> <ul style="list-style-type: none"> <li>• (4) – <b>160 mm</b> cable, connects server board CPU0 or CPU1 x4 SlimSAS connector to Midplane card x4 SlimSAS connector.</li> </ul> <p><b>Note:</b> To support 24 NVMe drives in front bay, need to order two midplane cards and 2 sets of this cable kit.</p>   |
|    | <p><b>iPC</b> CYPBLSLMIDPOUT<br/> <b>MM#</b> 99AJF7<br/> <b>UPC</b> 00735858475174<br/> <b>EAN</b> 5032037213127<br/> <b>MOQ</b> 1</p> | <p>Used in 2U 2.5" systems with greater than 16 PCIe NVMe drives in front bay.</p> <p><b>Kit Includes:</b></p> <ul style="list-style-type: none"> <li>• (1) – <b>110 mm</b> cable, connects Midplane card x8 SlimSAS connector to HSBP x8 SlimSAS connector. One cable per connection.</li> </ul> <p><b>Note:</b> To support 24 NVMe drives in front bay, need to order two midplane cards and 12 sets of this cable kit.</p>   |
|   | <p><b>iPC</b> CYPBLSL204KIT<br/> <b>MM#</b> 99A5A7<br/> <b>UPC</b> 00735858475181<br/> <b>EAN</b> 5032037213134<br/> <b>MOQ</b> 1</p>  | <p>Used in 2U 3.5" systems (M50CYP2UR312) to support PCIe NVMe drives in front drive bay</p> <p><b>Included in cable kit: CYPBLSL204KIT</b></p> <ul style="list-style-type: none"> <li>• (1) – <b>200 mm</b> cable, connects server board CPU0 x4 SlimSAS B connector to HSBP x4 SlimSAS SSD5 connector</li> <li>• (1) – <b>180 mm</b> cable, connects server board CPU1 4x SlimSAS B connector to HSBP x4 SlimSAS SSD7 connector</li> <li>• (1) – <b>175 mm</b> cable, connects server board CPU0 x4 SlimSAS A connector to HSBP x4 SlimSAS SSD4 connector</li> <li>• (1) – <b>205 mm</b> cable, connects server board CPU1 x4 SlimSAS A connector on HSBP x4 SlimSAS SSD6 connector</li> </ul>  |
|  | <p><b>iPC</b> CYPBLSL112KIT<br/> <b>MM#</b> 99A5A8<br/> <b>UPC</b> 00735858475198<br/> <b>EAN</b> 5032037213141<br/> <b>MOQ</b> 1</p>  | <p>Used in 1U 12 x 2.5" system (M50CYP1UR212) to support PCIe NVMe drives in front drive bay</p> <p><b>Kit Includes:</b></p> <ul style="list-style-type: none"> <li>• (1) – <b>412/420 mm</b> splitter cable, connects server board CPU0 x4 SlimSAS A and B connectors (RRA) to HSBP x8 SlimSAS SSD0-1 connector (VT)</li> <li>• (1) – <b>400/392 mm</b> splitter cable, connects server board CPU1 x4 SlimSAS C (RRA) and D connectors to HSBP x8 SlimSAS SSD10-11 connector (VT)</li> <li>• (1) – <b>350/342 mm</b> splitter cable, connects server board CPU0 x4 SlimSAS C (RRA) and D connectors to HSBP x8 SlimSAS SSD2-3 connector (VT)</li> <li>• (1) – <b>312/320 mm</b> splitter cable, connects server board CPU1 x4 SlimSAS A and B connectors (RRA) to HSBP x8 SlimSAS SSD8-9 connector (VT)</li> </ul> |

| Image   | Details   | Description   |
|---|---|---|
|    | <p><b>iPC</b> CYPCLSL104KIT<br/> <b>MM#</b> 99A5A9<br/> <b>UPC</b> 00735858475204<br/> <b>EAN</b> 5032037213158<br/> <b>MOQ</b> 2</p> | <p>Used in 1U 4 x 2.5" system (M50CYP1UR204) to support PCIe NVMe drives in front drive bay</p> <p><b>Kit Includes:</b></p> <ul style="list-style-type: none"> <li>• (1) – <b>412/420 mm</b> splitter cable, connects server board CPU0 x4 SlimSAS A and B connectors (RRA) to HSBP x8 SlimSAS PCIe SSD 0–1 connector (VT)</li> </ul> <p><b>Note:</b> Need to order additional cable kit to connect server board CPU1 x4 SlimSAS A and B connectors (RRA) to HSBP x8 SlimSAS PCIe SSD 2–3 connector (VT)</p>  |
|    | <p><b>iPC</b> CYPCLSLRTRKIT<br/> <b>MM#</b> 99A67F<br/> <b>UPC</b> 00735858475211<br/> <b>EAN</b> 5032037213165<br/> <b>MOQ</b> 1</p> | <p>Used in 1U/2U systems supporting additional NVMe drives in front drive bay.</p> <p><b>Kit Includes:</b></p> <p>(2) – <b>660 mm</b> cables</p> <p>Usage in 2U systems</p> <ul style="list-style-type: none"> <li>• (1) – <b>660 mm</b> cable, connects Riser #1 NVMe riser card x8 SlimSAS PCIe_SSD_0-1 connector to HSBP x8 SlimSAS SSD0-1 connector</li> <li>• (1) – <b>660 mm</b> cable, connects Riser #1 NVMe riser card x8 SlimSAS PCIe_SSD_2-3 connector to HSBP x8 SlimSAS SSD2-3 connector</li> </ul> <p>Usage in 1U x 12 front drive bay systems</p> <ul style="list-style-type: none"> <li>• (1) – <b>660 mm</b> cable, connects Riser #3 NVMe riser card x8 SlimSAS PCIe_SSD_0-1 connector to HSBP x8 SlimSAS SSD4-5 or SSD6-7 or SSD8-9 or SSD10-11 connectors</li> <li>• (1) – <b>660 mm</b> cable, connects Riser #3 NVMe riser card x8 SlimSAS PCIe_SSD_2-3 connector to HSBP x8 SlimSAS SSD4-5 or SSD6-7 or SSD8-9 or SSD10-11 connectors</li> </ul> |
|   | <p><b>iPC</b> CYPCLSLSLX8<br/> <b>MM#</b> 99AJR4<br/> <b>UPC</b> 00735858487528<br/> <b>EAN</b> 5032037224109<br/> <b>MOQ</b> 1</p>   | <p>Used in 1U/2U systems to support additional NVMe drives in front drive bay.</p> <p><b>Kit Includes:</b></p> <ul style="list-style-type: none"> <li>• (1) – <b>860 mm</b> cable, connects add-in card x8 SlimSAS connector to HSBP x8 SlimSAS connector</li> <li>• (1) – <b>1 m</b> cable, connects add-in card x8 SlimSAS connector to HSBP x8 SlimSAS connector</li> </ul>  |
|  | <p><b>iPC</b> CYPCLHDHDX1<br/> <b>MM#</b> 99AJF8<br/> <b>UPC</b> 00735858475228<br/> <b>EAN</b> 5032037213172<br/> <b>MOQ</b> 1</p>   | <p>Used in 1U/2U systems to support SAS/SATA drives in front drive bay. Usage varies depending on front drive bay configuration.</p> <p><b>Kit Includes:</b></p> <ul style="list-style-type: none"> <li>• (1) – <b>640 mm</b> cable, connects add-in card Mini SAS HD connector to HSBP Mini SAS HD connector (VT to VT)</li> <li>• (1) – <b>840 mm</b> cable, connects add-in card Mini SAS HD connector to HSBP Mini SAS HD connector (RA to VT)</li> <li>• (1) – <b>930 mm</b> cable, connects add-in card or server board Mini SAS HD connector to HSBP Mini SAS HD connector (RA to VT)</li> </ul>   |



| Image   | Details  | Description  |
|---|--|--|
|    | <p><b>iPC</b> CYPCLHDHDX2<br/> <b>MM#</b> 99AJF9<br/> <b>UPC</b> 00735858475235<br/> <b>EAN</b> 5032037213189<br/> <b>MOQ</b> 1</p>  | <p>Used in 1U/2U x8 systems to support SAS/SATA drives in front drive bay.</p> <p><b>Kit Includes:</b></p> <ul style="list-style-type: none"> <li>• (1) – <b>180 mm</b> cable, connects SAS ROC module Mini SAS HD connector to HSBP Mini SAS HD Port 0–3 connector</li> <li>• (1) – <b>250 mm</b> cable, connects SAS ROC module Mini SAS HD connector to HSBP Mini SAS HD Port 4–7 connector</li> </ul>  |
|    | <p><b>iPC</b> CYPCLHDHDX<br/> <b>MM#</b> 99AJFA<br/> <b>UPC</b> 00735858475242<br/> <b>EAN</b> 5032037213196<br/> <b>MOQ</b> 1</p>   | <p>Used in 2U systems to provide additional support for SAS/SATA drives in front drive bay using SAS Expander card.</p> <p><b>Note:</b> For 16 or more SAS/SATA drives in the front drive bay, a SAS Expander card is needed.</p> <p><b>Kit Includes:</b></p> <ul style="list-style-type: none"> <li>• (1) – <b>540 mm</b> cable, connects SAS ROC module Mini SAS HD output connector to SAS Expander card Mini SAS HD G or H or I connector</li> </ul> |
|   | <p><b>iPC</b> CYPCLMEZKIT<br/> <b>MM#</b> 99AJFC<br/> <b>UPC</b> 00735858475136<br/> <b>EAN</b> 5032037213080<br/> <b>MOQ</b> 1</p>  | <p>Used in 1U/2U systems to connect ROC modules.</p> <p><b>Kit Includes:</b></p> <ul style="list-style-type: none"> <li>• (1) – <b>385 mm</b> cable, connects ROC module Mini SAS HD connector (LS) to HSBP Mini SAS HD connector (VT)</li> <li>• (2) – <b>140 mm</b> cable, connects ROC module Mini SAS HD connector (RS) to HSBP Mini SAS HD connector (RA)</li> </ul>  |
|  | <p><b>iPC</b> CYPCLSLHDKIT<br/> <b>MM#</b> 99AMXX<br/> <b>UPC</b> 00735858497350<br/> <b>EAN</b> 5032037232494<br/> <b>MOQ</b> 1</p> | <p>Used in 1U/2U systems to connect add-in cards to HSBP.</p> <p><b>Kit Includes:</b></p> <ul style="list-style-type: none"> <li>• (1) – <b>860 mm</b> cable, RAID x8 SlimSAS connector to HSBP x4 Mini-SAS HD connector</li> <li>• (1) – <b>660 mm</b> cable, RAID x8 SlimSAS connector to HSBP x4 Mini-SAS HD connector</li> </ul>   |

| Image   | Details  | Description   |
|---|--|---|
|    | <p><b>iPC</b> CYPBLSLRVx2OUT<br/> <b>MM#</b> 99AMXT<br/> <b>UPC</b> 00735858497329<br/> <b>EAN</b> 5032037232463<br/> <b>MOQ</b> 1</p> | <p>Used in M50CYP2UR x24 system to connect Midplane card to HSBP for front NVMe drive support.</p> <p><b>Kit Includes:</b></p> <ul style="list-style-type: none"> <li>• (1) – 110 mm cable, Midplane card x8 SlimSAS connector to HSBP 2 x8 SlimSAS connectors</li> <li>• (1) – 160 mm cable, Midplane card x8 SlimSAS connector to HSBP 2 x8 SlimSAS connectors</li> <li>• (2) – 200 mm cable, Midplane card x8 SlimSAS connector to HSBP 2 x8 SlimSAS connectors</li> <li>• (1) – 260 mm cable, Midplane card x8 SlimSAS connector to HSBP 2 x8 SlimSAS connectors</li> <li>• (1) – 340 mm cable, Midplane card x8 SlimSAS connector to HSBP 2 x8 SlimSAS connectors</li> </ul> |
|    | <p><b>iPC</b> CYPBLSLSSRIS<br/> <b>MM#</b> 99AMXV<br/> <b>UPC</b> 00735858497336<br/> <b>EAN</b> 5032037232470<br/> <b>MOQ</b> 1</p>   | <p>Used in 1U/2U systems to connect tri-mode RAID add-in card to HSBP for front NVMe drive support.</p> <p><b>Kit Includes:</b></p> <ul style="list-style-type: none"> <li>• (1) – 860 mm cable, add-in card x8 SlimSAS connector to HSBP 2 x8 SlimSAS connectors</li> <li>• (1) – 760 mm cable, add-in card x8 SlimSAS connector to HSBP 2 x8 SlimSAS connectors</li> </ul>  |
|   | <p><b>iPC</b> CYPBLSLAIC2RV<br/> <b>MM#</b> 99AMXW<br/> <b>UPC</b> 00735858497343<br/> <b>EAN</b> 5032037232487<br/> <b>MOQ</b> 1</p>  | <p>Used in M50CYP2UR x24 system to connect tri-mode RAID add-in card to Midplane card for front NVMe drive support.</p> <p><b>Kit Includes:</b></p> <ul style="list-style-type: none"> <li>• (1) – 420 mm cable, add-in card x8 SlimSAS connector to Midplane card 2 x4 SlimSAS connectors</li> <li>• (1) – 550 mm cable, add-in card x8 SlimSAS connector to Midplane card 2 x4 SlimSAS connectors</li> </ul>  |
|  | <p><b>iPC</b> CYPBLSL2216NX2<br/> <b>MM#</b> 99AP97<br/> <b>UPC</b> 00735858499712<br/> <b>EAN</b> 5032037234702<br/> <b>MOQ</b> 1</p> | <p>Used in M50CYP2UR x16 system to connect SB CPU0 SlimSAS connectors to HSBP (on the right) for front NVMe drive support.</p> <p><b>Kit Includes:</b></p> <ul style="list-style-type: none"> <li>• (1) – 370/390 mm cable, SB CPU0 x4 SlimSAS C/D to HSBP x8 SlimSAS connector that connects to SSD 10/11, VT → VT</li> <li>• (1) – 412/420 mm cable, SB CPU0 x4 SlimSAS A/B to HSBP x8 SlimSAS connector that connects to SSD 8/9, VT → VT</li> </ul>   |

| Image   | Details  | Description   |
|---|--|---|
|  | <p> <b>iPC</b> CYPBLSLHDKIT<br/> <b>MM#</b> 99AMXX<br/> <b>UPC</b> 00735858497350<br/> <b>EAN</b> 5032037232494<br/> <b>MOQ</b> 1                 </p> | <p>Used in 1U/2U systems to connect tri-mode RAID add-in card to HSBP for front SAS/SATA up to 16 drive support.</p> <p><b>Kit Includes:</b></p> <ul style="list-style-type: none"> <li>• (1) – 860 mm cable, RAID x8 SlimSAS connector to HSBP 2 x4 Mini-SAS HD connectors</li> <li>• (1) – 660 mm cable, RAID x8 SlimSAS connector to HSBP 2 x4 Mini-SAS HD connectors</li> </ul> |

### 4.2.3 Cable Recommendations

Each table in the following sections identifies the cable connections and recommended cable lengths for each supported storage controller option in the specified system. Each recommended cable length for a given connector pair provides enough cable to attach the two devices and provides the least amount of excess cable, providing the cleanest cable routing.

Refer to the following diagrams when **Right** or **Left** cable routing is specified for a given cable configuration. All cable recommendations are for a system configured for two processors.

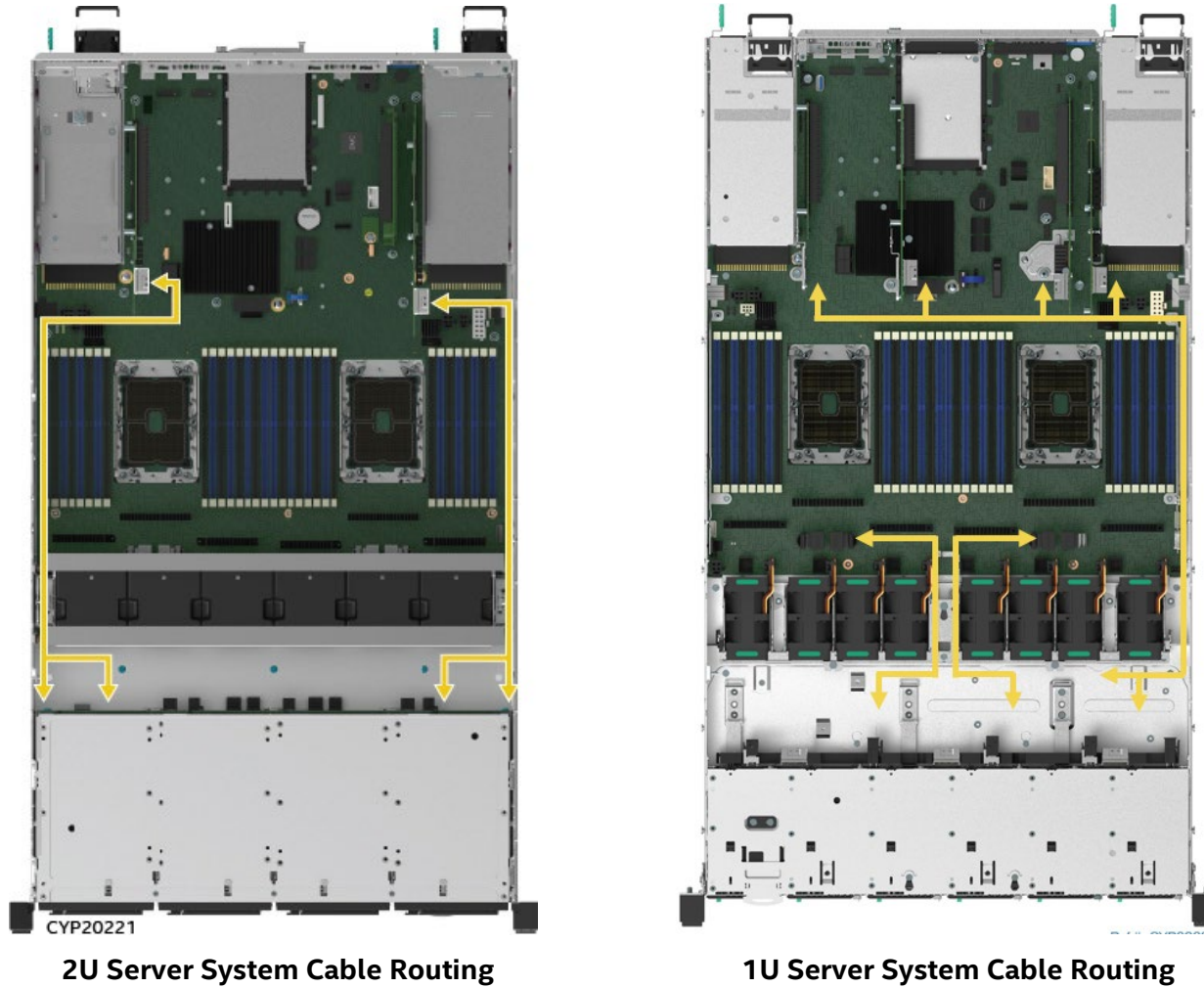


Figure 22. Server System Cable Routing

### 4.3 1U 4 x 2.5" – M50CYP1UR204 SAS /SATA / NVMe\* Data Cable Guide

M50CYP1UR204xxx



Figure 22. 4 x 2.5" Front Drive Bay Configuration – M50CYP1UR204

**Note:** A splitter cable is a cable that has two or more connectors on one end.

Table 19. Data Cable Guide for Intel® Server System M50CYP1UR204

| Drive Support  | SATA<br>Server Board (SB) Mini-SAS<br>HD SATA → Backplane (BP)<br>Mini SAS HD  | SAS/SATA<br>12 Gb SAS ROC Module Mini-<br>SAS HD → Backplane (BP)<br>Mini-SAS HD   | SAS/SATA<br>12 Gb SAS RAID PCIe*<br>Add-in Card mini SAS HD<br>→ Backplane (BP) mini<br>SAS HD   | NVMe*<br>NVMe* Server Board (SB) x4<br>PCIe* SlimSAS → Backplane<br>(BP) x8 PCIe SlimSAS   | NVMe*<br>Riser 3 PCIe NVMe<br>Riser Card x8 SlimSAS<br>→ Backplane (BP) x8<br>SlimSAS |
|--|--|--|--|--|---|
| <p>4 x 2.5"</p> <ul style="list-style-type: none"> <li>6 Gb SATA all drives</li> <li>12 Gb SAS all drives</li> <li>PCIe* NVMe* all drives</li> </ul> | <p>SB SATA (0-3) → BP SATA Port 0-3</p> <ul style="list-style-type: none"> <li>Included in cable kit: <b>CYPCBLHDHDX1</b></li> <li>840 mm cable, RA → VT</li> <li>Routed along the right side of chassis.</li> </ul> | <p><b>Part 1:</b> Connecting server board → SAS Interposer card (iPC <b>CYPSASMODINT</b>).</p> <hr/> <p><b>Note:</b> SAS Interposer card is needed to enable SAS ROC module. Cable kit iPC <b>CYPCBLSLINTKIT</b> is used to connect server board to SAS Interposer card. Both SlimSAS connectors on the SAS Interposer card must be connected to the same CPU. The remaining SlimSAS connector connected to the same CPU cannot be used for NVMe front drive bay connectivity.</p> | <p>Add-in card connected to Riser 1 card or PCIe Interposer card or Riser 2 card: -</p> <p>Add-in card SATA (0-3) → BP SATA Port 0-3</p> <ul style="list-style-type: none"> <li>Included in cable kit: iPC <b>CYPCBLHDHDX1</b></li> <li>930 mm cable, VT → RA.</li> <li>Routed along the right side of chassis.</li> </ul> | <p>All cables are routed through the middle of fan assembly</p> <p>SB CPU0 x4 SlimSAS A and B → BP x8 SlimSAS PCIe SSD 0-1</p> <ul style="list-style-type: none"> <li>412/420 mm splitter cable, RRA → VT.</li> <li>Routed through the middle of the fan assembly</li> </ul> <p>SB CPU1 x4 SlimSAS A and B → BP x8 SlimSAS PCIe SSD 2-3</p> <ul style="list-style-type: none"> <li>412/420 mm splitter cable, RRA → VT</li> <li>Routed through the middle of the fan assembly</li> </ul> <p>Cable kit: iPC <b>CYPCBLSL104KIT</b> includes</p> <p>(1) 412/420 mm splitter cable</p> | <p><b>NOT SUPPORTED</b></p>   |

| Drive Support | <b>SATA</b><br>Server Board (SB) Mini-SAS<br>HD SATA → Backplane (BP)<br>Mini SAS HD | <b>SAS/SATA</b><br>12 Gb SAS ROC Module Mini-<br>SAS HD → Backplane (BP)<br>Mini-SAS HD  | <b>SAS/SATA</b><br>12 Gb SAS RAID PCIe*<br>Add-in Card mini SAS HD<br>→ Backplane (BP) mini<br>SAS HD | <b>NVMe*</b><br>NVMe* Server Board (SB) x4<br>PCIe* SlimSAS → Backplane<br>(BP) x8 PCIe SlimSAS | <b>NVMe*</b><br>Riser 3 PCIe NVMe<br>Riser Card x8 SlimSAS<br>→ Backplane (BP) x8<br>SlimSAS |
|---------------|--|--|---|---|--|
|               |  | <p>SB CPU0 x4 SlimSAS A or<br/>                     CPU1 x4 SlimSAS D → SAS<br/>                     Interposer card x4 SlimSAS A</p> <ul style="list-style-type: none"> <li>• 250 mm cable, VT → RA</li> <li>• Routed through middle of fan assembly.</li> </ul> <p>SB CPU0 x4 SlimSAS A or<br/>                     CPU1 x4 SlimSAS D → SAS<br/>                     Interposer card x4 SlimSAS B</p> <ul style="list-style-type: none"> <li>• 250 mm cable, RRA → RA</li> <li>• Routed through middle of fan assembly.</li> </ul> <p>The above required cables are in cable kit: iPC<br/> <b>CYPCBLSLINTKIT</b></p> <hr/> <p><b>Part 2:</b> Connecting SAS Interposer card → BP.</p> <hr/> <p><b>Note:</b> The ROC module connects to the mezzanine connector on the SAS Interposer card.</p> <p><b>ROC Mini SAS HD PORT 0 → BP SATA 0–3</b></p> <ul style="list-style-type: none"> <li>• Included in cable kit: iPC<br/> <b>CYPCBLMEZKIT</b></li> <li>• 385 mm cable, LS → VT</li> </ul> |   |   |  |

## 4.4 1U 12 x 2.5" – M50CYP1UR212 SAS / SATA / NVMe\* Data Cable Guide

### M50CYP1UR212xxx



Figure 23. 12 x 2.5" Front Drive Bay Configuration – M50CYP1UR212

**Note:** A splitter cable is a cable that has two or more connectors on one end.

Table 20. Data Cable Guide for Intel® Server System M50CYP1UR212

| Drive Support   | SATA<br>Server Board (SB) Mini-SAS HD SATA →<br>Backplane (BP) Mini-SAS HD  | SAS/SATA<br>SAS Mezzanine 12 Gb SAS ROC Module Mini-SAS HD →<br>Backplane (BP) Mini-SAS HD  | SAS/SATA<br>12 Gb SAS RAID PCIe* Add-in Card mini SAS HD →<br>Backplane (BP) mini SAS HD   | NVMe*<br>Server Board (SB) PCIe* NVMe* x4 SlimSAS →<br>Backplane (BP) x8 SlimSAS  | NVMe*<br>Riser 3 PCIe NVMe Riser Card x8 SlimSAS →<br>Backplane (BP) x8 SlimSAS   |
|---|---|---|--|---|---|
| <p>12 x 2.5"</p> <ul style="list-style-type: none"> <li>6 Gb SATA all drives</li> <li>12 Gb SAS all drives</li> <li>PCIe* NVMe* all drives</li> </ul> | <p>SB SATA (0-3) → BP SATA Port 4-7</p> <ul style="list-style-type: none"> <li>930 mm cable, RA → VT</li> <li>Routed along the right side of chassis.</li> </ul> <p>SB SATA (4-7) → BP SATA Port 8-11</p> <ul style="list-style-type: none"> <li>840 mm cable, RA → VT</li> <li>Routed along the right side of chassis.</li> </ul> <p>Required cables above are in cable kit:<br/><b>CYPCBLHDHDXXX1</b></p> | <p><b>Part 1:</b> Connecting server board → SAS Interposer card (iPC <b>CYPSASMODINT</b>).</p> <hr/> <p><b>Note:</b> SAS Interposer card is needed to enable SAS ROC module. Cable kit iPC <b>CYPCBLSLINTKIT</b> is used to connect server board to SAS Interposer card. Both SlimSAS connectors on the SAS Interposer card must be connected to the same CPU. The remaining SlimSAS connector connected to the same CPU cannot be used for NVMe* front drive bay connectivity.</p> | <p><b>Note:</b> Cables are routed along the right side of chassis.</p> <hr/> <p><b>Add-in card on Riser 2 card:-</b></p> <p><b>Add-in card PORT 0 → BP SATA Port 0-3</b></p> <ul style="list-style-type: none"> <li>930 mm cable, VT → RA.</li> </ul> <p><b>Add-in card PORT 1 → BP SATA Port 4-7</b></p> <ul style="list-style-type: none"> <li>840 mm cable, VT → RA.</li> </ul> <p><b>Add-in card PORT 2 → BP SATA Port 8-11</b></p> <ul style="list-style-type: none"> <li>640 mm cable, VT → VT.</li> </ul> | <p>SB CPU0 SlimSAS A and B → BP SlimSAS SSD0-1</p> <ul style="list-style-type: none"> <li>412/420 mm splitter cable, RRA → VT</li> <li>Routed through middle of fan assembly</li> </ul> <p>SB CPU0 SlimSAS C and D → BP SlimSAS SSD2-3</p> <ul style="list-style-type: none"> <li>350/342 mm splitter cable, RRA → VT</li> <li>Routed along left of chassis.</li> </ul> <p>SB CPU1 SlimSAS A and B → BP SlimSAS SSD8-9</p> <ul style="list-style-type: none"> <li>312/320 mm cable, RRA → VT</li> <li>Routed along right of chassis.</li> </ul> | <p>Riser 3 NVMe riser card SlimSAS PCIe_SSD_0-1 connector → BP SlimSAS SSD4-5 or SSD6-7 or SSD8-9 or SSD10-11</p> <ul style="list-style-type: none"> <li>660 mm cable, VT → VT</li> <li>Routed along right of chassis.</li> </ul> <p>Riser 3 NVMe riser card SlimSAS PCIe_SSD_2-3 connector → BP SlimSAS SSD4-5 or SSD6-7 or SSD8-9 or SSD10-11</p> <ul style="list-style-type: none"> <li>660 mm cable, VT → VT</li> <li>Routed along right of chassis.</li> </ul> |

| Drive Support | SATA<br>Server Board (SB) Mini-SAS HD SATA →<br>Backplane (BP) Mini-SAS HD | SAS/SATA<br>SAS Mezzanine 12 Gb SAS ROC Module Mini-SAS HD →<br>Backplane (BP) Mini-SAS HD  | SAS/SATA<br>12 Gb SAS RAID PCIe* Add-in Card mini SAS HD →<br>Backplane (BP) mini SAS HD  | NVMe*<br>Server Board (SB) PCIe* NVMe* x4 SlimSAS →<br>Backplane (BP) x8 SlimSAS   | NVMe*<br>Riser 3 PCIe NVMe Riser Card x8 SlimSAS →<br>Backplane (BP) x8 SlimSAS |
|---------------|--|---|---|--|---|
|               |  | <p>SB CPU0 x4 SlimSAS A or CPU1 x4 SlimSAS D → SAS Interposer card x4 SlimSAS A</p> <ul style="list-style-type: none"> <li>• 250 mm cable, VT → RA</li> <li>• Routed through middle of fan assembly.</li> </ul> <p>SB CPU0 x4 SlimSAS A or CPU1 x4 SlimSAS D → SAS Interposer card x4 SlimSAS A</p> <ul style="list-style-type: none"> <li>• 250 mm cable, RRA → RA</li> <li>• Routed through middle of fan assembly.</li> </ul> <p>Required cables above are in cable kit: iPC <b>CYPCBLSLINTKIT</b></p> <hr/> <p><b>Part 2: Connecting SAS Interposer card → BP.</b></p> <hr/> <p>ROC Mini SAS HD PORT 0 → BP SATA 0-3</p> <ul style="list-style-type: none"> <li>• 385 mm cable, Left side → VT</li> </ul> <p>ROC Mini SAS HD PORT 1 → BP SATA 4-7</p> <ul style="list-style-type: none"> <li>• 140 mm cable, right side → RA</li> </ul> <p>ROC Mini SAS HD PORT 2 → BP SATA 8-11</p> <ul style="list-style-type: none"> <li>• 140 mm cable, right side → RA</li> </ul> <p>Required cables above are in cable kit: iPC <b>CYPCBLMEZKIT</b></p> | <p>Required cables above are in cable kit: iPC <b>CYPCBLHDHDX1</b></p> <p><b>Add-in card on Riser 1 card or Interposer card:-</b></p> <p><b>Add-in card PORT 0 → BP SATA Port 4-7</b></p> <ul style="list-style-type: none"> <li>• 930 mm cable, VT → RA.</li> </ul> <p><b>Add-in card PORT 1 → BP SATA Port 8-11</b></p> <ul style="list-style-type: none"> <li>• 810 mm cable, VT → RA.</li> </ul> <p>Required cables above are in cable kit: iPC <b>CYPCBLHDHDX1</b></p> | <p>SB CPU1 SlimSAS C and D → BP SlimSAS SSD10-11</p> <ul style="list-style-type: none"> <li>• 400/392 mm splitter cable, RRA → VT</li> <li>• Routed through middle of fan assembly</li> </ul> <p>Required cables above are in cable kit: iPC <b>CYPCBLSL112KIT</b></p> | <p>Required cables above are in cable kit: iPC <b>CYPCBLSLRTKIT</b></p>         |



## 4.5 2U 2.5" Front Mount Drive Bay Cable Guide

The 2U 2.5" system can support up to 24 front drive bays using three 8 x 2.5" SAS/SATA NVMe\* drive combo backplanes.

The 2U 2.5" system supports the following system configurations: 8 drives (**M50CYP2UR208**), 16 drives (**M50CYP2UR208 + 8 Drive Accessory Kit**), or 24 drives (**M50CYP2UR208 + two 8 Drive Accessory Kits**).

The front side of the backplane includes eight 68-pin SFF-8639 drive interface (U.2) connectors, each capable of supporting SAS, SATA, or NVMe\* drives. The connectors are labeled "SSD\_0" through "SSD\_7".

The backside of the backplane includes two multiport Mini-SAS HD connectors labeled "SAS/SATA PORT 0-3" and "SAS/SATA PORT 4-7", and four x8 PCIe\* SlimSAS\* connectors, labeled "PCIe\* SSD 0-1", "PCIe\* SSD 2-3", "PCIe\* SSD 4-5", and "PCIe\* SSD 6-7". Each x8 PCIe\* SlimSAS\* connector is routed to two U.2 connectors on the front side. For example, PCIe\* SSD 0-1 is routed to SSD\_0 and SSD\_1.

### 4.5.1 M50CYP2UR208 SAS / SATA / NVMe\* Data Cable Guide for up to 8 Front Drive Bays

**Note:** Drive numbering in the system illustrations is for general reference only. Actual drive numbering is dependent on SAS/SATA controller configuration and how they are cabled to the backplane.



Figure 24. 2U 8 x 2.5" Front Drive Bay Configuration – M50CYP2UR208

**Note:** A splitter cable is a cable that has two or more connectors on one end.

**Table 21. M50CYP2UR208 Cable Guide for up to 8 Front Drive Bays**

| Drive Support   | SATA<br>Server Board (SB) Mini-SAS HD SATA → Backplane (BP) Mini-SAS HD  | SAS/SATA<br>Mezzanine SAS ROC Module → Backplane (BP)   | SAS/SATA<br>12 Gb SAS RAID PCIe* Add-in Card mini SAS HD → Backplane (BP) mini SAS HD  | NVMe*<br>Server Board (SB) PCIe* NVMe* x4 SlimSAS → Backplane (BP) x8 SlimSAS   | NVMe*<br>PCIe* NVMe* Riser Card x8 SlimSAS → Backplane (BP) x8 SlimSAS  |
|---|--|---|--|---|---|
| <p><b>8 x 2.5"</b></p> <ul style="list-style-type: none"> <li>• 6 Gb SATA all drives</li> <li>• 12 Gb SAS all drives</li> <li>• PCIe* NVMe* all drives</li> </ul> | <p><b>SB SATA (0-3) → BP SATA Port 0-3</b></p> <ul style="list-style-type: none"> <li>• <b>840 mm</b> cable, RA → VT</li> <li>• Routed along the left side of chassis.</li> </ul> <p><b>SB SATA (4-7) → BP SATA Port 4-7</b></p> <ul style="list-style-type: none"> <li>• <b>930 mm</b> cable, RA → VT</li> <li>• Routed along the left side of chassis.</li> </ul> <p>Required cables above are in cable kit: <b>CYPCBLHDHDX1</b></p> | <hr/> <p><b>Part 1:</b> Connecting server board → SAS Interposer card (iPC <b>CYPSASMODINT</b>).</p> <hr/> <p><b>Note:</b> SAS Interposer card is needed to enable SAS ROC module. Cable kit iPC <b>CYPCBLSLINTKIT</b> is used to connect server board to SAS Interposer card. Both SlimSAS connectors on the SAS Interposer card must be connected to the same CPU. The remaining SlimSAS connector connected to the same CPU cannot be used for NVMe* front drive bay connectivity.</p> <hr/> <p><b>SB CPU0 x4 SlimSAS A or CPU1 x4 SlimSAS D → SAS Interposer card x4 SlimSAS A</b></p> <ul style="list-style-type: none"> <li>• <b>250 mm</b> cable, VT → RA</li> <li>• Routed underneath fan assembly.</li> </ul> <p><b>SB CPU0 x4 SlimSAS B or CPU1 x4 SlimSAS C → SAS Interposer card x4 SlimSAS B</b></p> <ul style="list-style-type: none"> <li>• <b>250 mm</b> cable, RRA → RA</li> <li>• Routed underneath fan assembly.</li> </ul> <p>Required cables above are in cable kit: iPC <b>CYPCBLSLINTKIT</b></p> | <p><b>Add-in card connected to Riser 1 card OR Riser 2 card OR Riser 3 card:-</b></p> <hr/> <p><b>Note:</b> If using Riser 1, route the cables through the left side of the chassis. If using Riser 2 or Riser 3, route the cables through the right side of the chassis.</p> <hr/> <p><b>Add-in card PORT 0 → BP SATA Port 0-3</b></p> <ul style="list-style-type: none"> <li>• <b>930 mm</b> cable, VT → RA.</li> </ul> <p><b>Add-in card PORT 1 → BP SATA Port 4-7</b></p> <ul style="list-style-type: none"> <li>• <b>840 mm</b> cable, VT → RA.</li> </ul> <p>Required cables above are in cable kit: iPC <b>CYPCBLHDHDX1</b></p> | <p>All cables are routed underneath the fan assembly</p> <p><b>SB CPU0 SlimSAS A and B → BP SlimSAS SSD0-1</b></p> <ul style="list-style-type: none"> <li>• <b>240/260 mm</b> splitter cable, VT → VT</li> </ul> <p><b>SB CPU0 SlimSAS C and D → BP SlimSAS SSD2-3</b></p> <ul style="list-style-type: none"> <li>• <b>330/310 mm</b> splitter cable, VT → VT</li> </ul> <p><b>SB CPU1 SlimSAS C and D → BP SlimSAS SSD6-7</b></p> <ul style="list-style-type: none"> <li>• <b>235/215 mm</b> splitter cable, VT → VT</li> </ul> <p><b>SB CPU1 SlimSAS A and B → BP SlimSAS SSD4-5</b></p> <ul style="list-style-type: none"> <li>• <b>370/390 mm</b> splitter cable, VT → VT</li> </ul> <p>Required cables above are in cable kit: iPC <b>CYPCBLSL208KIT</b></p> | <p>From Riser 1 NVMe* Riser card:</p> <p><b>SlimSAS PCIe_SSD_0-1 → BP SlimSAS SSD0-1</b></p> <ul style="list-style-type: none"> <li>• <b>660 mm</b> cable, VT → VT</li> <li>• Routed along left of chassis.</li> </ul> <p><b>SlimSAS PCIe_SSD_2-3 → BP SlimSAS SSD2-3</b></p> <ul style="list-style-type: none"> <li>• <b>660 mm</b> cable, VT → VT</li> <li>• Routed along left of chassis.</li> </ul> <p>From Riser 3 NVMe* Riser card:</p> <p><b>SlimSAS PCIe_SSD_0-1 → BP SlimSAS SSD4-5</b></p> <ul style="list-style-type: none"> <li>• <b>660 mm</b> cable, VT → VT</li> <li>• Routed along right of chassis.</li> </ul> <p><b>SlimSAS PCIe_SSD_2-3 → BP SlimSAS SSD6-7</b></p> <ul style="list-style-type: none"> <li>• <b>660 mm</b> cable, VT → VT</li> <li>• Routed along right of chassis.</li> </ul> <p>Required cables above are in cable kit: iPC <b>CYPCBLSLRKIT</b> that contains (2) <b>660 mm</b> cable, VT → VT</p> |

| Drive Support | SATA<br>Server Board (SB) Mini-SAS HD SATA →<br>Backplane (BP) Mini-SAS HD | SAS/SATA<br>Mezzanine SAS ROC Module →<br>Backplane (BP)   | SAS/SATA<br>12 Gb SAS RAID PCIe*<br>Add-in Card mini SAS HD →<br>Backplane (BP) mini SAS HD | NVMe*<br>Server Board (SB) PCIe*<br>NVMe* x4 SlimSAS →<br>Backplane (BP) x8 SlimSAS | NVMe*<br>PCIe* NVMe* Riser Card x8<br>SlimSAS → Backplane (BP)<br>x8 SlimSAS |
|---------------|--|--|---|---|--|
|               |  | <hr/> <p><b>Part 2:</b> Connecting SAS Interposer card → BP.</p> <hr/> <p><b>Note:</b> The ROC module connects to the mezzanine connector on the SAS Interposer card.</p> <hr/> <p><b>ROC Mini SAS HD PORT 0 → BP SATA 0–3</b></p> <ul style="list-style-type: none"> <li>• 180 mm cable, VT → VT</li> </ul> <p><b>ROC Mini SAS HD PORT 1 → BP SATA 4–7</b></p> <ul style="list-style-type: none"> <li>• 250 mm cable, VT → VT</li> </ul> <p>Required cables above are in cable kit: iPC<br/><b>CYPCBLHDHDX2</b></p> |   |   |  |

#### 4.5.2 M50CYP2UR 16 x 2.5" SAS / SATA / NVMe\* Data Cable Guide

**Note:** For M50CYP2UR 16 x 2.5" configurations, ensure the ventilation blank is installed in the middle of the chassis as shown in the following figure.

**Note:** Drive numbering in the system illustrations is for general reference only. Actual drive numbering is dependent on SAS/SATA controller configuration and how they are cabled to the backplane.



CYP20162

**Figure 25. 2U 16 x 2.5" Front Drive Bay Configuration**

The following accessory kits are needed to convert a M50CYP2UR208 system into a 9–16 front drive bay configuration.

- (1) 8 x 2.5" Hot Swap backplane kit **CYPHSBP2208**
- (8) 2.5" front drive bay module **CYP25HSCARRIER**

**Note:** Support for connectivity between 12 Gb SAS RAID PCIe add-in card and SAS Expander card is planned as part of post product launch release.

**Table 22. 2U 2.5" SAS/SATA Cable Guide for 9–16 Front Drive Bays**

| Drive Support  | SATA<br>Server Board (SB) Mini-SAS HD<br>SATA → Backplane (BP) Mini-SAS HD  | SAS/SATA<br>Mezzanine SAS ROC Module →<br>Backplane (BP)   | SAS/SATA<br>12 Gb SAS RAID PCIe* Add-in Card<br>mini SAS HD → Backplane (BP) mini<br>SAS HD  | SAS/SATA<br>4 or 8-port 12Gb SAS RAID PCIe* Add-<br>in Card → 12 Gb SAS Expander →<br>Backplane (BP)  |
|--|---|--|--|---|
| <p><b>16 x 2.5"</b></p> <ul style="list-style-type: none"> <li>• 6 Gb SATA all drives</li> <li>• 12 Gb SAS all drives</li> </ul> | <p><b>SB SATA (0-3) or SATA (4-7) → BP SATA Port 0-3 or Port 4-7 or Port 8-11</b></p> <ul style="list-style-type: none"> <li>• 840 mm cable, RA → VT</li> <li>• Routed along the left side of chassis.</li> </ul> <p><b>SB SATA (0-3) or SATA (4-7) → BP SATA Port 12-15</b></p> <ul style="list-style-type: none"> <li>• 930 mm cable, RA → VT</li> <li>• Routed along the left side of chassis.</li> </ul> <p>Required cables above are in cable kit: iPC <b>CYPCBLHDHDX1</b></p> | <p><b>Part 1:</b> Connecting server board → SAS Interposer card (iPC <b>CYPSASMODINT</b>).</p> <hr/> <p><b>Note:</b> SAS Interposer card is needed to enable SAS ROC module. Cable kit iPC <b>CYPCBLSLINTKIT</b> is used to connect server board to SAS Interposer card. Both SlimSAS connectors on the SAS Interposer card must be connected to the same CPU. The remaining SlimSAS connector connected to the same CPU cannot be used for NVMe* front drive bay connectivity.</p> <hr/> <p><b>SB CPU0 x4 SlimSAS A or CPU1 x4 SlimSAS D → SAS Interposer card x4 SlimSAS A</b></p> <ul style="list-style-type: none"> <li>• 250 mm cable, VT → RA</li> <li>• Routed underneath fan assembly.</li> </ul> <p><b>SB CPU0 x4 SlimSAS B or CPU1 x4 SlimSAS C → SAS Interposer card x4 SlimSAS B</b></p> <ul style="list-style-type: none"> <li>• 250 mm cable, RRA → RA</li> <li>• Routed underneath fan assembly.</li> </ul> <p>Required cables above are in cable kit: iPC <b>CYPCBLSLINTKIT</b></p> <hr/> <p><b>Part 2:</b> Connecting SAS Interposer card → BP.</p> | <p><b>Add-in card connected to Riser 1 card or Riser 2 card or Riser 3 card:-</b></p> <hr/> <p><b>Note:</b> If using Riser 1, route the cables through the left side of the chassis. If using Riser 2 or Riser 3, route the cables through the right side of the chassis.</p> <hr/> <p><b>Add-in card PORT 0 → BP SATA Port 0-3</b></p> <ul style="list-style-type: none"> <li>• 930 mm cable, VT → RA.</li> </ul> <p><b>Add-in card PORT 1 → BP SATA Port 4-7</b></p> <ul style="list-style-type: none"> <li>• 840 mm cable, VT → RA.</li> </ul> <p><b>Add-in card PORT 2 → BP SATA Port 8-11</b></p> <ul style="list-style-type: none"> <li>• 640 mm cable, VT → VT.</li> </ul> <p>Required cables above are in cable kit: iPC <b>CYPCBLHDHDX1</b></p> <hr/> <p><b>Add-in card PORT 3 → BP SATA Port 12-15</b></p> <ul style="list-style-type: none"> <li>• 640 mm cable, VT → VT.</li> </ul> <hr/> <p><b>Note:</b> Need to order an additional iPC <b>CYPCBLHDHDX1</b> cable kit to support add-in card PORT 3 connectivity</p> | <p><b>Part 1:</b> Connecting Add-in card → SAS Expander card (iPC <b>RES3TV360</b>)</p> <hr/> <p>(See <a href="#">Figure 26</a> for SAS port mapping)</p> <p><b>Add-in card connected to Riser 1 card or Riser 2 card or Riser 3 card:-</b></p> <hr/> <p><b>Note:</b> If using Riser 1, route the cables through the left side of the chassis. If using Riser 2 or Riser 3, route the cables through the right side of the chassis.</p> <hr/> <p><b>Add-in card PORT 0 → SAS Expander 0-3 (G)</b></p> <ul style="list-style-type: none"> <li>• 930 mm cable, VT → RA.</li> </ul> <p><b>Add-in card PORT 1 → SAS Expander 4-7 (H)</b></p> <ul style="list-style-type: none"> <li>• 840 mm cable, VT → RA.</li> </ul> <p>Required cables above are in cable kit: iPC <b>CYPCBLHDHDX1</b></p> <hr/> <p><b>Part 2:</b> Connecting SAS Expander card → BP</p> <hr/> <p>Use <b>RES3TV360</b> accessory kit.<br/><b>Kit includes:</b></p> <ul style="list-style-type: none"> <li>(1) – SAS expander card</li> <li>(1) – 130 mm power cable</li> <li>(4) – 165 mm cable, Expander card HD to HSBP HD</li> <li>(1) – 300 mm cable, Expander card HD to HSBP HD</li> <li>(1) – 250 mm cable, Expander card HD to BP HD</li> <li>(3) – rubber pads</li> <li>mounting screws</li> </ul> |

| Drive Support | SATA<br>Server Board (SB) Mini-SAS HD<br>SATA → Backplane (BP) Mini-SAS HD | SAS/SATA<br>Mezzanine SAS ROC Module →<br>Backplane (BP)  | SAS/SATA<br>12 Gb SAS RAID PCIe* Add-in Card<br>mini SAS HD → Backplane (BP) mini SAS HD | SAS/SATA<br>4 or 8-port 12Gb SAS RAID PCIe* Add-in Card → 12 Gb SAS Expander → Backplane (BP) |
|---------------|--|---|--|---|
|               |  | <p><b>Note:</b> The ROC module connects to the mezzanine connector on the SAS Interposer card.</p> <hr/> <p><b>ROC Mini SAS HD PORT 0 → BP SATA 0–3</b></p> <ul style="list-style-type: none"> <li>• 540 mm cable, VT → VT</li> </ul> <p><b>ROC Mini SAS HD PORT 1 → BP SATA 4–7</b></p> <ul style="list-style-type: none"> <li>• 540 mm cable, VT → VT</li> </ul> <p><b>ROC Mini SAS HD PORT 2 → BP SATA 8–11</b></p> <ul style="list-style-type: none"> <li>• 250 mm cable, VT → VT</li> </ul> <p><b>ROC Mini SAS HD PORT 3 → BP SATA 12–15</b></p> <ul style="list-style-type: none"> <li>• 180 mm cable, VT → VT</li> </ul> <p>Cable kit iPC <b>CYPCBLHDHDXXX2</b> contains:</p> <ul style="list-style-type: none"> <li>(1) 180 mm cable, VT → VT</li> <li>(1) 250 mm cable, VT → VT</li> </ul> <p>Cable kit iPC <b>CYPCBLHDHDXXX</b> contains:</p> <ul style="list-style-type: none"> <li>(1) 540 mm cable, VT → VT</li> </ul> |  |   |

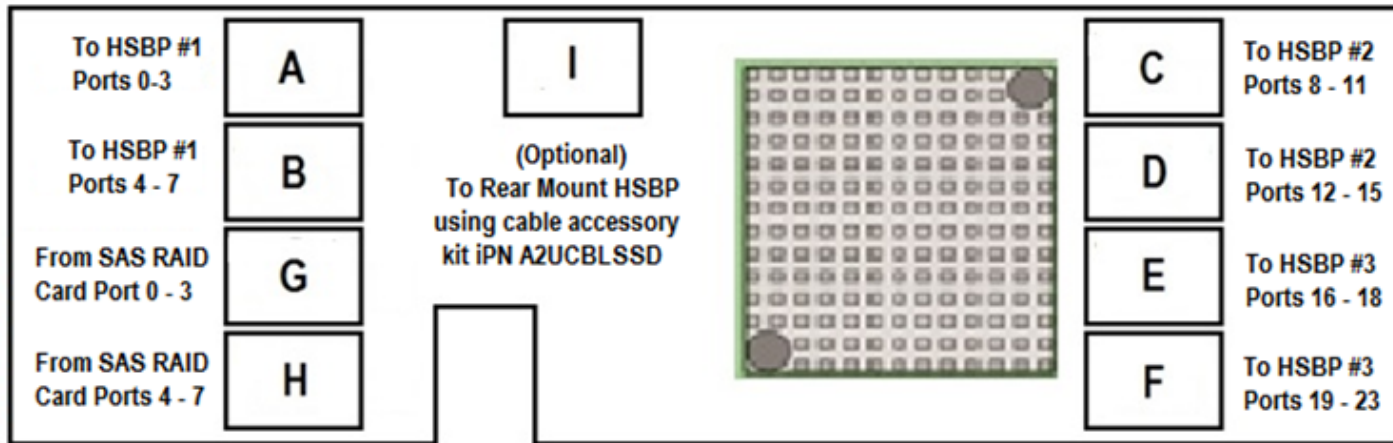


Figure 26. SAS Expander RES3TV360 Port Mapping

**Note:** A splitter cable is a cable that has two or more connectors on one end.

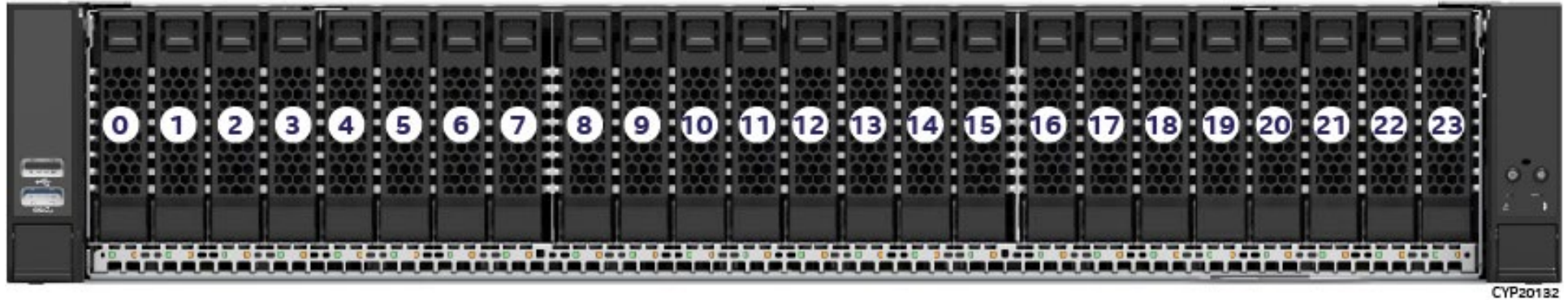
Table 23. 2U 2.5" PCIe\* NVMe\* Cable Guide for 9–16 Front Drive Bays

| Drive Support   | Server Board (SB) PCIe* NVMe* x4 SlimSAS → Backplane (BP) x8 SlimSAS   | PCIe* NVMe* Riser Card x8 SlimSAS → Backplane (BP) x8 SlimSAS  |
|---|--|--|
| <p>16 x 2.5"</p> <ul style="list-style-type: none"> <li>PCIe* NVMe* all drives</li> </ul> | <p>All cables are routed under the fan assembly</p> <p>SB CPU0 SlimSAS C and D → BP SlimSAS SSD6-7</p> <ul style="list-style-type: none"> <li>275/255 mm splitter cable, VT → VT</li> </ul> <p>SB CPU0 SlimSAS A and B → BP SlimSAS SSD4-5</p> <ul style="list-style-type: none"> <li>305/325 mm splitter cable, VT → VT</li> </ul> <p>SB CPU1 SlimSAS C and D → BP SlimSAS SSD14-15</p> <ul style="list-style-type: none"> <li>360/340 mm splitter cable, VT → VT</li> </ul> <p>SB CPU1 SlimSAS A and B → BP SlimSAS SSD12-13</p> <ul style="list-style-type: none"> <li>260/240 mm splitter cable, VT → VT</li> </ul> <p>Required cables above are in cable kit: iPC CYPCLSL216KIT</p> | <p>From Riser 1 NVMe* Riser card:</p> <p>SlimSAS PCIe_SSD_0-1 → BP SlimSAS SSD0-1</p> <ul style="list-style-type: none"> <li>660 mm cable, VT → VT</li> <li>Routed along left of chassis.</li> </ul> <p>SlimSAS PCIe_SSD_2-3 → BP SlimSAS SSD2-3</p> <ul style="list-style-type: none"> <li>660 mm cable, VT → VT</li> <li>Routed along left of chassis.</li> </ul> <p>Required cables above are in cable kit: CYPCLSLRTRKIT that contains (2) 660 mm cable, VT → VT</p> <p>From Riser 3 NVMe* Riser card:</p> <p>SlimSAS PCIe_SSD_0-1 → BP SlimSAS SSD8-9</p> <ul style="list-style-type: none"> <li>660 mm cable, VT → VT</li> <li>Routed along right of chassis.</li> </ul> <p>SlimSAS PCIe_SSD_2-3 → BP SlimSAS SSD10-11</p> <ul style="list-style-type: none"> <li>660 mm cable, VT → VT</li> </ul> |

| Drive Support | Server Board (SB) PCIe* NVMe* x4 SlimSAS → Backplane (BP) x8 SlimSAS | PCIe* NVMe* Riser Card x8 SlimSAS → Backplane (BP) x8 SlimSAS   |
|---------------|--|---|
|               |  | <ul style="list-style-type: none"> <li>• Routed along right of chassis.</li> </ul> <p>Required cables above are in cable kit: iPC CYPBLSLRKIT that contains (2) 660 mm cable, VT → VT</p> |

### 4.5.3 M50CYP2UR 24 x 2.5" SAS / SATA / NVMe\* Data Cable Guide

**Note:** Drive numbering in the system illustrations is for general reference only. Actual drive numbering is dependent on SAS/SATA controller configuration and how they are cabled to the backplane



**Figure 27. 2U 24 x 2.5" M50CYP2UR208 Front Drive Bay Configuration**

The following accessory kits are needed to convert a M50CYP2UR208 system into a 17– 24 front drive bay configuration.

- (2) 8 x 2.5" Hot Swap backplane kit CYPHSBP2208
- (16) 2.5" front drive bay module CYP25HSCARRIER

**Note:** Support for connectivity between 12 Gb SAS RAID PCIe\* add-in card and SAS Expander card is planned as part of post product launch releases.



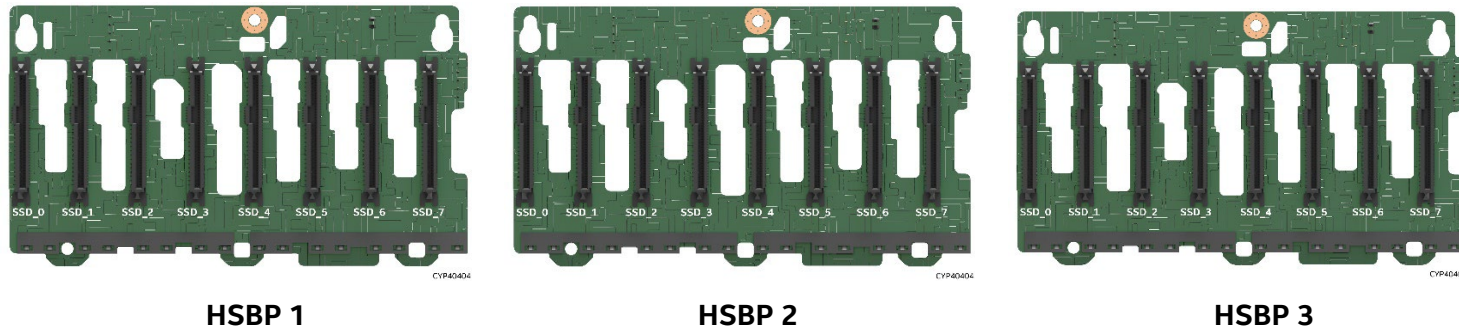


Figure 28. 2U 2.5" x 24 System HSBP Enumeration

Table 24. 2U 2.5" SAS / SATA Cable Guide for 17–24 Front Drive Bays

| Drive Support   | SATA<br>Server Board (SB) Mini-SAS HD SATA → Backplane (BP) Mini-SAS HD   | SAS/SATA<br>12 Gb SAS RAID PCIe* Add-in Card mini SAS HD → Backplane (BP) mini SAS HD  | SAS/SATA<br>4 or 8-port Mezzanine 12Gb SAS ROC Module → SAS Expander Card → Backplane (BP)   | SAS/SATA<br>4 or 8-port 12Gb SAS RAID PCIe* Add-in Card → 12 Gb SAS Expander → Backplane (BP)  |
|---|---|--|--|--|
| <b>24 x 2.5"</b> <ul style="list-style-type: none"> <li>6 Gb SATA all drives</li> <li>12 Gb SAS all drives</li> </ul> | <p><b>SB SATA (0-3) or SATA (4-7) → BP any SATA Port, except Port 20–23</b></p> <ul style="list-style-type: none"> <li>840 mm cable, RA → VT</li> <li>Routed along the left side of chassis.</li> </ul> <p><b>SB SATA (0-3) or SATA (4-7) → BP SATA Port 20–23</b></p> <ul style="list-style-type: none"> <li>930 mm cable, RA → VT</li> <li>Routed along the left side of chassis.</li> </ul> <p>Required cables above are in cable kit: iPC <b>CYPCBLHDHDX1</b></p> | <p><b>Add-in card connected to Riser 1 card or Riser 2 card or Riser 3 card:-</b></p> <p><b>Note:</b> If using Riser 1, route the cables through the left side of the chassis. If using Riser 2 or Riser 3, route the cables through the right side of the chassis.</p> <p><b>Add-in card PORT 0 → BP SATA Port 16–19</b></p> <ul style="list-style-type: none"> <li>930 mm cable, VT → RA.</li> </ul> <p><b>Add-in card PORT 1 → BP SATA Port 20–23</b></p> <ul style="list-style-type: none"> <li>840 mm cable, VT → RA.</li> </ul> <p>Required cables above are in cable kit: iPC <b>CYPCBLHDHDX1</b></p> | <p><b>Part 1:</b> Connecting server board → SAS Interposer card (iPC <b>CYPSASMODINT</b>).</p> <p><b>Note:</b> SAS Interposer card is needed to enable SAS ROC module. Cable kit <b>CYPCBLSLINTKIT</b> is used to connect server board to SAS Interposer card. Both SlimSAS connectors on the SAS Interposer card must be connected to the same CPU. The remaining SlimSAS connector connected to the same CPU cannot be used for NVMe* front drive bay connectivity.</p> <p><b>SB CPU0 x4 SlimSAS A or CPU1 x4 SlimSAS D → AS Interposer card x4 SlimSAS A</b></p> <ul style="list-style-type: none"> <li>250 mm cable, VT → RA</li> <li>Routed underneath fan assembly.</li> </ul> | <p><b>PART 1:</b> Connecting Add-in card → SAS Expander card (iPC <b>RES3TV360</b>)</p> <p>(See <a href="#">Figure 26</a> for SAS port mapping)</p> <p><b>Add-in card connected to Riser 1 card or Riser 2 card or Riser 3 card:-</b></p> <p><b>Note:</b> If using Riser 1, route the cables through the left side of the chassis. If using Riser 2 or Riser 3, route the cables through the right side of the chassis.</p> <p><b>Add-in card PORT 0 → SAS Expander 0–3 (G)</b></p> <ul style="list-style-type: none"> <li>930 mm cable, VT → RA.</li> </ul> <p><b>Add-in card PORT 0 → SAS Expander 0–3 (H)</b></p> <ul style="list-style-type: none"> <li>840 mm cable, VT → RA.</li> </ul> <p>Required cables above are in cable kit: iPC <b>CYPCBLHDHDX1</b></p> |

**SB CPU0 x4 SlimSAS B or CPU1 x4 SlimSAS C → SAS Interposer card x4 SlimSAS B**

- 250 mm cable, RRA → RA
- Routed underneath fan assembly.

The above required cables are in cable kit: iPC **CYPCBLSLINTKIT**

**Part 2: Connecting ROC Module to SAS Expander card.**

**Add-in card PORT 0 → SAS Expander 0-3 (G)**

- 540 mm cable, VT → VT.

**Add-in card PORT 0 → SAS Expander 0-3 (H)**

- 540 mm cable, VT → VT.

Cable kit iPC **CYPCBLHDHDXXX** includes:  
 (1) 540 mm cable, VT → VT

**Part 3: Connecting Expander card to BP.**

**Included with SAS Expander Module: RES3TV360 kit**

(4) 165 mm cable, Mini SAS HD from SAS Expander card → Mini SAS HD on HSBP 1 and 2.

(1) 250 mm cable Mini SAS HD from SAS Expander card → Mini SAS HD on HSBP 3.

(1) 300 mm cable, Mini SAS HD from SAS Expander card → Mini SAS HD on HSBP 1 and 2. x

(1) 130 mm cable, Power cable (2x2 pin to two 2x2 pin), server board (Left) → SAS ROC module.

**PART 2: Connecting SAS Expander card → BP**

(See [Figure 28](#))

**Included with SAS Expander Module: iPC RES3TV360 kit**

(4) 165 mm cable, Mini SAS HD from SAS Expander card → Mini SAS HD on HSBP 1 and 2.

(1) 250 mm cable, Mini SAS HD from SAS Expander card → Mini SAS HD on HSBP 3.

(1) 300 mm cable, Mini SAS HD from SAS Expander card → Mini SAS HD on HSBP 1 and 1.

(1) 130 mm cable, Power cable (2x2 pin to two 2x2 pin), server board-Left → SAS ROC module.

**Table 25. 2U 2.5" PCIe\* NVMe\* Cable Guide for 17–24 Front Drive Bays**

| Drive Support  | Left Midplane Card x8 SlimSAS → Backplane (BP) x8 SlimSAS  | Right Midplane x8 SlimSAS → Backplane (BP) x8 SlimSAS   |
|--|--|---|
| <p><b>24 x 2.5"</b></p> <ul style="list-style-type: none"> <li>• PCIe* NVMe* all drives</li> </ul>   | <p><b>Part 1: Connecting SB → Midplane Card</b></p>  | <p><b>Part 1: Connecting server board (SB) → Midplane card:</b></p>   |
|  | <p><b>Note:</b> All cables below are routed under fan assembly.</p>  | <p><b>Note:</b> All cables below are routed under fan assembly.</p>   |
|  | <p><b>SB CPU0 SlimSAS A → Midplane SlimSAS PCIe* Port A</b></p> <ul style="list-style-type: none"> <li>• 160 mm cable, VT → VT</li> </ul>  | <p><b>SB CPU1 SlimSAS A → Midplane SlimSAS PCIe* Port A</b></p> <ul style="list-style-type: none"> <li>• 160 mm cable, VT → VT</li> </ul> |
|  | <p><b>SB CPU0 SlimSAS B → Midplane SlimSAS PCIe* Port B</b></p> <ul style="list-style-type: none"> <li>• 160 mm cable, VT → VT</li> </ul>  | <p><b>SB CPU1 SlimSAS B → Midplane SlimSAS PCIe* Port B</b></p> <ul style="list-style-type: none"> <li>• 160 mm cable, VT → VT</li> </ul> |
|  | <p><b>SB CPU0 SlimSAS C → Midplane SlimSAS PCIe* Port C</b></p> <ul style="list-style-type: none"> <li>• 160 mm cable, VT → VT</li> </ul>  | <p><b>SB CPU1 SlimSAS C → Midplane SlimSAS PCIe* Port C</b></p> <ul style="list-style-type: none"> <li>• 160 mm cable, VT → VT</li> </ul> |
| <p><b>SB CPU0 SlimSAS D → Midplane SlimSAS PCIe* Port D</b></p> <ul style="list-style-type: none"> <li>• 160 mm cable, VT → VT</li> </ul>  | <p><b>SB CPU1 SlimSAS D → Midplane SlimSAS PCIe* Port D</b></p> <ul style="list-style-type: none"> <li>• 160 mm cable, VT → VT</li> </ul>  |   |
| <p><b>Included in cable kit: iPC CYPBLSLMIDPIN</b></p> <p>(4) 160 mm cable SB SlimSAS (x4) → Midplane card SlimSAS (x4)</p>  | <p><b>Included in cable kit: iPC CYPBLSLMIDPIN</b></p> <p>(4) 160 mm cable SB SlimSAS (x4) → Midplane card SlimSAS (x4)</p>  |   |
| <p><b>Part 2: Connecting Midplane Card → Backplanes</b></p>  | <p><b>Part 2: Connecting Midplane card → Backplanes</b></p>  |   |
| <ul style="list-style-type: none"> <li>• SSD0-SSD1 x8 SlimSAS connector on Midplane → HSBP 0 SSD0 and SSD1</li> <li>• SSD2-SSD3 x8 SlimSAS connector on Midplane → HSBP 0 SSD2 and SSD3</li> <li>• SSD4-SSD5 x8 SlimSAS connector on Midplane → HSBP 0 SSD4 and SSD5</li> <li>• SSD6-SSD7 x8 SlimSAS connector on Midplane → HSBP 0 SSD6 and SSD7</li> <li>• SSD8-SSD9 x8 SlimSAS connector on Midplane → HSBP 1 SSD0 and SSD1</li> <li>• SSD10-SSD11 x8 SlimSAS connector on Midplane → HSBP 1 SSD2 and SSD3</li> </ul> <p><b>Included in cable kit: iPC CYPBLSLMIDPOUT</b></p> <p>(1) 110 mm cable Midplane card SlimSAS (x8) → HSBP SlimSAS (x8).</p> | <ul style="list-style-type: none"> <li>• SSD0-SSD1 x8 SlimSAS connector on Midplane → HSBP 1 SSD4 and SSD5</li> <li>• SSD2-SSD3 x8 SlimSAS connector on Midplane → HSBP 1 SSD6 and SSD7</li> <li>• SSD4-SSD5 x8 SlimSAS connector on Midplane → HSBP 2 SSD0 and SSD1</li> <li>• SSD6-SSD7 x8 SlimSAS connector on Midplane → HSBP 2 SSD2 and SSD3</li> <li>• SSD8-SSD9 x8 SlimSAS connector on Midplane → HSBP 2 SSD4 and SSD5</li> <li>• SSD10-SSD11 x8 SlimSAS connector on Midplane → HSBP 2 SSD6 and SSD7</li> </ul> <p><b>Included in cable kit: iPC CYPBLSLMIDPOUT</b></p> <p>(1) 110 mm cable Midplane card SlimSAS (x8) → HSBP SlimSAS (x8).</p> |   |

## 4.6 2U 12 x 3.5" – M50CYP2UR312 SAS / SATA / NVMe\* Data Cable Guide

M50CYP2UR312xxx



CYP20161

Figure 29. 2U 12 x 3.5" M50CYP2UR312 Front Drive Bay Configuration

Table 26. 2U 12 x 3.5" M50CYP2UR312 SAS / SATA / NVMe\* Cable Guide

| Drive Support   | SATA<br>Server Board (SB) Mini-SAS HD SATA → Backplane (BP) Mini-SAS HD  | SAS/SATA<br>SAS Mezzanine SAS ROC Module → Backplane (BP) | SAS/SATA<br>12 Gb SAS RAID PCIe* Add-in Card mini SAS HD → Backplane (BP) mini SAS HD   | NVMe*<br>Server Board (SB) PCIe* NVMe* x4 SlimSAS → Backplane (BP) x4 SlimSAS  | NVMe*<br>PCIe* NVMe* Riser Card x8 SlimSAS → Backplane (BP) x8 SlimSAS |
|---|--|---|---|--|--|
| <p>12 x 3.5"</p> <ul style="list-style-type: none"> <li>6 Gb SATA all drives</li> <li>12 Gb SAS all drives</li> <li>PCIe* NVMe* on four drive bays</li> </ul> | <p>SB SATA (0-3) → BP SATA Port 0-3 or Port 4-7</p> <ul style="list-style-type: none"> <li>840 mm cable, RA → VT</li> <li>Routed along the left side of chassis.</li> </ul> <p>SB SATA (4-7) → BP SATA Port 4-7 or Port 8-11</p> <ul style="list-style-type: none"> <li>930 mm cable, RA → VT</li> <li>Routed along the left side of chassis.</li> </ul> | NOT SUPPORTED   | <p>Add-in card connected to Riser 1 card OR Riser 2 card OR Riser 3 card:-</p> <hr/> <p><b>Note:</b> If using Riser 1, route the cables through the left side of the chassis. If using Riser 2 or Riser 3, route the cables through the right side of the chassis.</p> <hr/> <p>Add-in card SATA PORT 0 → BP SATA Port 0-3</p> <ul style="list-style-type: none"> <li>930 mm cable, VT → RA.</li> </ul> | <p>Route the following cables under the fan assembly.</p> <p>SB CPU0 SlimSAS A→BP SlimSAS PCIe_SSD_4</p> <ul style="list-style-type: none"> <li>175 mm cable, VT → VT</li> </ul> <p>SB CPU0 SlimSAS B→BP SlimSAS PCIe_SSD_5</p> <ul style="list-style-type: none"> <li>200 mm cable, VT → VT</li> </ul> <p>SB CPU1 SlimSAS A→BP SlimSAS PCIe_SSD_6</p> <ul style="list-style-type: none"> <li>205 mm cable, VT → VT</li> </ul> | NOT SUPPORTED  |

Intel® Server M50CYP Family Configuration Guide

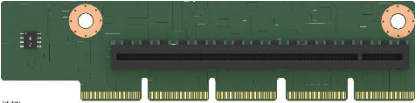
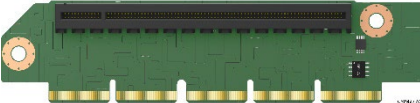
| Drive Support | SATA<br>Server Board (SB) Mini-SAS HD SATA →<br>Backplane (BP) Mini-SAS HD | SAS/SATA<br>SAS Mezzanine SAS ROC Module → Backplane (BP) | SAS/SATA<br>12 Gb SAS RAID PCIe* Add-in Card mini SAS HD →<br>Backplane (BP) mini SAS HD  | NVMe*<br>Server Board (SB) PCIe* NVMe* x4 SlimSAS →<br>Backplane (BP) x4 SlimSAS  | NVMe*<br>PCIe* NVMe* Riser Card x8 SlimSAS → Backplane (BP) x8 SlimSAS |
|---------------|--|---|---|---|--|
|               | <p>Required cables above are in cable kit: iPC<br/><b>CYPCBLHDHDX1</b></p> |   | <p>Add-in card SATA PORT 1 → BP SATA Port 4–7</p> <ul style="list-style-type: none"> <li>• 840 mm cable, VT → RA.</li> </ul> <p>Add-in card SATA PORT 2 → BP SATA Port 8–11</p> <ul style="list-style-type: none"> <li>• 640 mm cable, VT → VT.</li> </ul> <p>Required cables above are in cable kit: iPC<br/><b>CYPCBLHDHDX1</b></p> | <p>SB CPU1 SlimSAS B→BP SlimSAS PCIe_SSD_7</p> <ul style="list-style-type: none"> <li>• 180 mm cable, VT → VT</li> </ul> <p>Required cables above are in cable kit: iPC<br/><b>CYPCBLSL204KIT</b></p> |  |





## 5. 1U / 2U System Optional Accessories

### 5.1 1U / 2U PCIe\* Riser Card Accessory / Spare FRU Options

#### 5.1.1 1U Riser Card Options

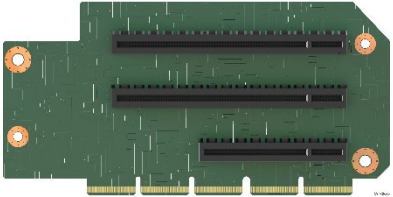
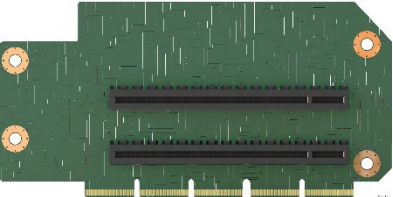
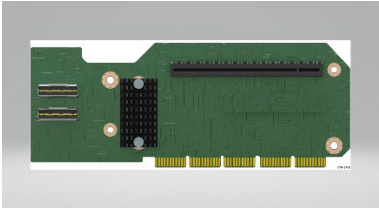
Table 27. 1U Riser Card Option

| Image   | Details   | Description  |
|---|---|--|
|  | <p><b>1U 1-Slot PCIe* Riser Card for Riser Slot #1</b></p> <p><b>iPC</b> CYP1URISER1STD<br/> <b>MM#</b> 99A3MX<br/> <b>UPC</b> 00735858471749<br/> <b>EAN</b> 5032037210188<br/> <b>MOQ</b> 1</p> <p><b>Product type</b> 1U building<br/> block/spare FRU<br/> 1U accessory kit</p> | <p>Riser card option for Riser Slot #1 only.</p> <p>The one-slot PCIe* riser card option supports:</p> <ul style="list-style-type: none"> <li>Slot 1 – One low profile, half-length, single-width add-in card (x16 electrical, x16 mechanical)</li> </ul> <p><b>Kit includes:</b><br/> (1) Riser card PCBA</p>   |
|  | <p><b>1U 1-Slot PCIe* Riser Card for Riser Slot #2</b></p> <p><b>iPC</b> CYP1URISER2STD<br/> <b>MM#</b> 99A3P9<br/> <b>UPC</b> 00735858471756<br/> <b>EAN</b> 5032037210195<br/> <b>MOQ</b> 1</p> <p><b>Product type</b> 1U building<br/> block/spare FRU<br/> 1U accessory kit</p> | <p>Riser card option for Riser Slot #2 only.</p> <p>The one-slot PCIe* riser card option supports:</p> <ul style="list-style-type: none"> <li>Slot 1 – One low profile, half-length, single-width add-in card (x16 electrical, x16 mechanical)</li> </ul> <p><b>Kit includes:</b><br/> (1) – Riser card PCBA</p> |

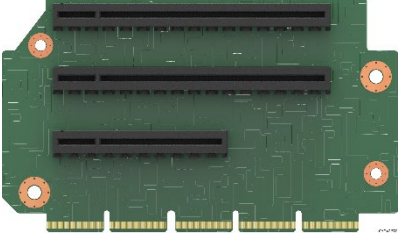
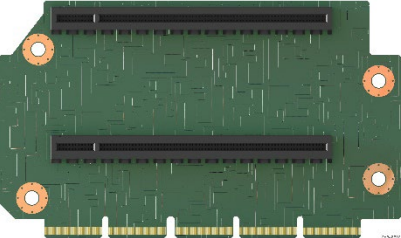
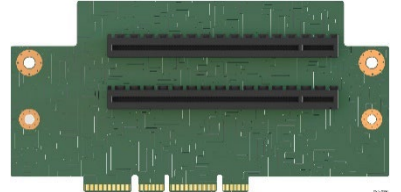
| Image  | Details  | Description   |
|--|--|---|
| <p>Interposer Riser Card</p>  <p>PCIe* Riser Card for Riser Slot #2</p>  <p>PCIe* Interposer Cable</p>  | <p><b>1U PCIe* Interposer Kit</b></p> <p><b>iPC</b> CYP1URISER2KIT<br/> <b>MM#</b> 99A3PF<br/> <b>UPC</b> 00735858471770<br/> <b>EAN</b> 5032037210218<br/> <b>MOQ</b> 1</p> <p><b>Product type</b> 1U building block/spare FRU<br/> 1U accessory kit</p>                            | <p>The two-slot PCIe* Interposer riser card option supports:</p> <ul style="list-style-type: none"> <li>Slot 1 (right side) — One low profile / half length, single-width add-in card. (x8 electrical, x8 mechanical)</li> <li>PCIe_SSD_0-1 (left side) – (x8 electrical, x8 mechanical)</li> </ul> <p>The two-slot PCIe* riser card option for Riser Slot #2 supports:</p> <ul style="list-style-type: none"> <li>Slot 1 (left side) — One low profile / half-length, single-width add-in card. (x16 electrical, x16 mechanical)</li> <li>PCIe_SSD_0-1 (right side) – (x8 electrical, x8 mechanical)</li> </ul> <p><b>Kit includes:</b><br/> (1) – Interposer riser card PCBA<br/> (1) – PCIe* riser card PCBA<br/> (1) – PCIe* Interposer cable</p> |
|   | <p><b>1U/2U PCIe* NVMe* Riser Card for Riser Slot #3</b></p> <p><b>iPC</b> CYPRISER3RTM<br/> <b>MM#</b> 99A3PA<br/> <b>UPC</b> 00735858471763<br/> <b>EAN</b> 5032037210201<br/> <b>MOQ</b> 1</p> <p><b>Product type</b> 1U/2U building block/spare FRU<br/> 1U/2U accessory kit</p> | <p>Riser card option for Riser Slot #3 only.</p> <p>The Two-Slot PCIe* NVMe* riser card supports two x8 PCIe* SlimSAS connectors labeled "PCIe_SSD_0-1" and "PCIe_SSD_2-3". Each connector supports up to two NVMe* SSDs in the front drive bay through a backplane.</p> <p>The two slot PCIe* NVMe* riser card option supports:</p> <ul style="list-style-type: none"> <li>PCIe_SSD_0-1 Slot (top) – (x8 electrical, x8 mechanical)</li> <li>PCIe_SSD_2-3 Slot (bottom) – (x8 electrical, x8 mechanical)</li> </ul> <p><b>Kit includes:</b><br/> (1) – Riser card</p>  |


5.1.2 2U Riser Card Options

Table 28. 2U Riser Card Options

| Image   | Details   | Description   |
|---|---|---|
|    | <p><b>2U 3-Slot PCIe* Riser Card for Riser Slot #1</b></p> <p><b>iPC</b> CYP2URISER1STD<br/> <b>MM#</b> 99A3P4<br/> <b>UPC</b> 00735858471695<br/> <b>EAN</b> 5032037210133<br/> <b>MOQ</b> 1</p> <p><b>Product type</b> 2U building<br/>                 block/spare FRU<br/>                 2U accessory kit</p> | <p>Riser card option for Riser Slot #1 only.</p> <p>The three-slot PCIe* riser card option supports:</p> <ul style="list-style-type: none"> <li>Slot 1 (top) – One full-height/full-length single-width add-in card slot (x16 electrical, x16 mechanical)</li> <li>Slot 2 (middle) – One full-height/full-length single-width add-in card slot (x8 electrical, x16 mechanical)</li> <li>Slot 3 (bottom) – One full-height/half-length single-width add-in card slot (x8 electrical, x8 mechanical)</li> </ul> <p><b>Kit includes:</b><br/>                 (1) – Riser card</p> |
|    | <p><b>2U 2-Slot PCIe* Riser Card for Riser Slot #1</b></p> <p><b>iPC</b> CYP2URISER1DBL<br/> <b>MM#</b> 99A3P5<br/> <b>UPC</b> 00735858471701<br/> <b>EAN</b> 5032037210140<br/> <b>MOQ</b> 1</p> <p><b>Product type</b> 2U building<br/>                 block/spare FRU<br/>                 2U accessory kit</p> | <p>Riser card option for Riser Slot #1 only.</p> <p>The two-slot PCIe* riser card option supports:</p> <ul style="list-style-type: none"> <li>Slot 1 (top) – One full-height/full-length double-width slot (x16 electrical, x16 mechanical)</li> <li>Slot 2 (bottom) – One full-height/half-length single-width slot (x16 electrical, x16 mechanical)</li> </ul> <p><b>Kit includes:</b><br/>                 (1) – Riser card</p>  |
|  | <p><b>2U PCIe* NVMe* Riser Card for Riser Slot #1</b></p> <p><b>iPC</b> CYP2URISER1RTM<br/> <b>MM#</b> 99A3P3<br/> <b>UPC</b> 00735858471688<br/> <b>EAN</b> 5032037210126<br/> <b>MOQ</b> 1</p> <p><b>Product type</b> 2U building<br/>                 block/spare FRU<br/>                 2U accessory kit</p>  | <p>Riser card option for Riser Slot #1 only.</p> <p>The PCIe* NVMe* riser card option supports:</p> <ul style="list-style-type: none"> <li>Slot 3 (top) – One half-length or full-length single-width slot (x16 electrical, x16 mechanical)</li> <li>Two x8 PCIe* NVMe* SlimSAS* connectors                         <ul style="list-style-type: none"> <li>– PCIe_SSD_0-1 (top) – (x8 electrical, x8 mechanical)</li> <li>– PCIe_SSD_2-3 (bottom) – (x8 electrical, x8 mechanical)</li> </ul> </li> </ul> <p><b>Kit includes:</b><br/>                 (1) – Riser card</p>     |



| Image  | Details   | Description  |
|--|---|--|
|   | <p><b>2U 3-Slot PCIe* Riser Card for Riser Slot #2</b></p> <p><b>iPC</b> CYP2URISER2STD<br/> <b>MM#</b> 99A3P6<br/> <b>UPC</b> 00735858471718<br/> <b>EAN</b> 5032037210157<br/> <b>MOQ</b> 1</p> <p><b>Product type</b> 2U building block/spare FRU<br/>2U accessory kit</p> | <p>Riser card option for Riser Slot #2 only.</p> <p>The three slot PCIe* Riser Card option supports:</p> <ul style="list-style-type: none"> <li>Slot 1 (top) – One full-height/full-length single-width slot (x16 electrical, x16 mechanical)</li> <li>Slot 2 (middle) – One full-height/full-length single-width slot (x8 electrical, x16 mechanical)</li> <li>Slot 3 (bottom) – One full-height/half-length single-width slot (x8 electrical, x8 mechanical)</li> </ul> <p><b>Kit includes:</b><br/>(1) – Riser card</p> |
|   | <p><b>2U 2-Slot PCIe* Riser Card for Riser Slot #2</b></p> <p><b>iPC</b> CYP2URISER2DBL<br/> <b>MM#</b> 99A3P7<br/> <b>UPC</b> 00735858471725<br/> <b>EAN</b> 5032037210164<br/> <b>MOQ</b> 1</p> <p><b>Product type</b> 2U building block/spare FRU<br/>2U accessory kit</p> | <p>Riser card option for Riser Slot #2 only.</p> <p>The two slot PCIe* Riser Card option supports:</p> <ul style="list-style-type: none"> <li>Slot 1 (top) – One full-height/full-length double-width slot (x16 electrical, x16 mechanical)</li> <li>Slot 2 (bottom) – One full-height/half-length single-width slot (x16 electrical, x16 mechanical)</li> </ul> <p><b>Kit includes:</b><br/>(1) – Riser card</p>  |
|  | <p><b>2U 2-Slot PCIe* Riser Card for Riser Slot #3</b></p> <p><b>iPC</b> CYP2URISER3STD<br/> <b>MM#</b> 99A3P8<br/> <b>UPC</b> 00735858471732<br/> <b>EAN</b> 5032037210171<br/> <b>MOQ</b> 1</p> <p><b>Product type</b> 2U building block/spare FRU<br/>2U accessory kit</p> | <p>Riser card option for Riser Slot #3 only.</p> <p>The two slot PCIe* riser card option supports:</p> <ul style="list-style-type: none"> <li>Slot 1 (top) – low profile/ half-length single-width slots (x8 electrical, x16 mechanical)</li> <li>Slot 2 (bottom) – low profile/ half-length single-width slots (x8 electrical, x16 mechanical)</li> </ul> <p><b>Kit includes:</b><br/>(1) – Riser card</p>  |

| Image   | Details   | Description  |
|---|---|--|
|  | <p><b>2U/1U 2-Slot PCIe* NVMe* Riser Card for Riser Slot #3</b></p> <p><b>iPC</b> CYPRISER3RTM<br/> <b>MM#</b> 99A3PA<br/> <b>UPC</b> 00735858471763<br/> <b>EAN</b> 5032037210201<br/> <b>MOQ</b> 1</p> <p><b>Product type</b> 2U/1U building block/spare FRU<br/>                 2U/1U accessory kit</p> | <p>Riser card option for Riser Slot #3 only.</p> <p>The two slot PCIe* NVMe* riser card option supports:</p> <ul style="list-style-type: none"> <li>• PCIe_SSD_0-1 (top) – (x8 electrical, x8 mechanical)</li> <li>• PCIe_SSD_2-3 (bottom) – (x8 electrical, x8 mechanical)</li> </ul> <p><b>Kit includes:</b><br/>                 (1) Riser card</p> |

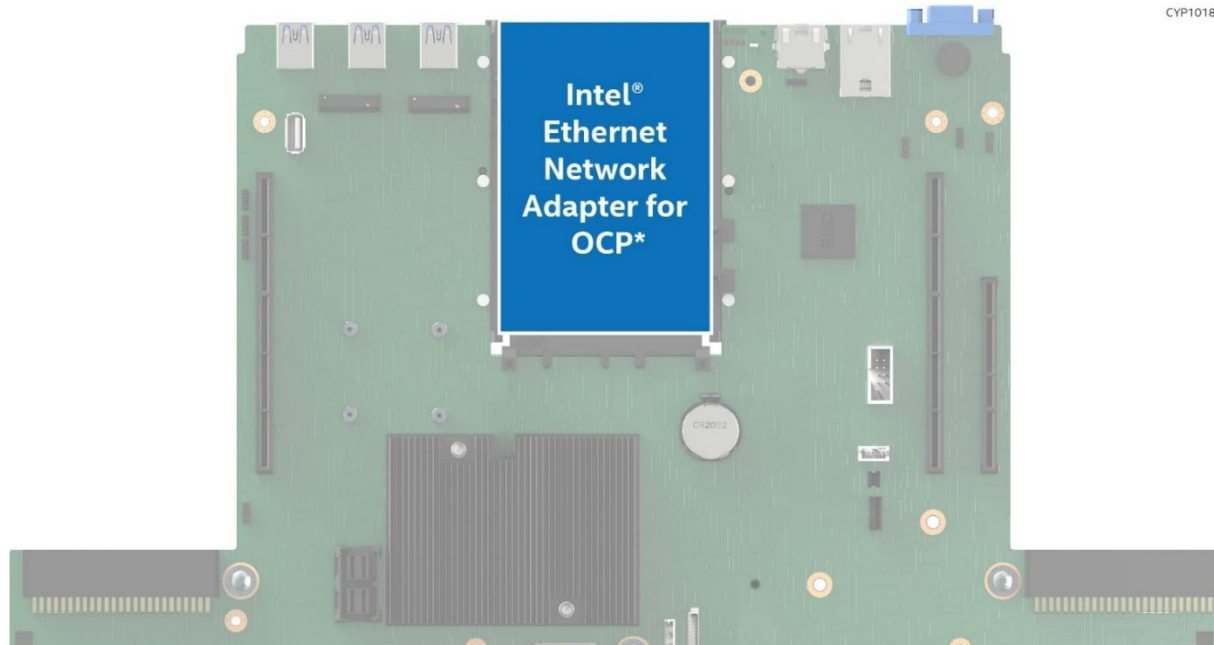
## 5.2 Intel® Ethernet Network Adapters for OCP\*

The server system supports several types of Intel® Ethernet Network Adapters (see [Table 29](#)). These adapters are compatible with the Open Compute Project\* (OCP\*) 3.0 specification. The OCP-compatible modules are mounted to a high-density 168-pin mezzanine connector on the server board labeled “OCP\_IO\_Module”. The following figure shows the OCP\* adapter placement on the server board.

---

**Note:** The Intel® Server M50CYP family only supports Intel® Ethernet Network Adapters for OCP\* that are listed in [Table 29](#).

---

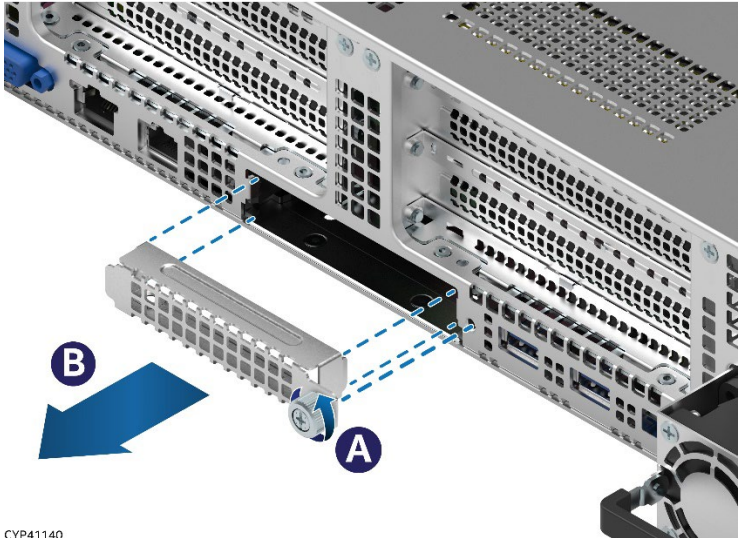


**Figure 30. Intel® Ethernet Network Adapter Placement**

All OCP\* module types support one of the three engagement mechanisms: pull tab, ejector latch, and internal lock. The engagement mechanism refers to the mechanism required to install / remove the OCP\* module.

OCP\* modules supported by the Intel® Server M50CYP family are installed into an OCP bay in the back of the server chassis. The modules are installed from the outside of the chassis. The following shows the installation of the pull tab engagement mechanism.

First remove the bay filler panel (see [Figure 31](#)). Then, carefully slide the module into the bay until it is fully seated in the OCP slot on the server board and is locked in place (see [Figure 32](#)). For more information on OCP\* module installation and removal of each OCP\* module type, see the *Intel® Server System M50CYP2UR Family System Integration and Service Guide* or *Intel® Server System M50CYP1UR Family System Integration and Service Guide*.



CYP41140





Figure 31. OCP\* Module Bay Filler Removal (2U System Shown)





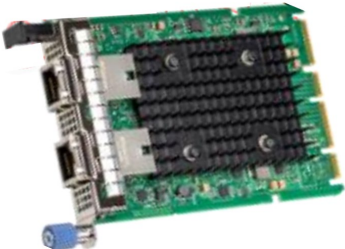

CYP41180

Figure 32. OCP\* Module with Pull tab Installation (2U System Shown)

Table 29. Intel® Ethernet Network Adapters for OCP\*

| Image   | Details  | Description   |
|---|--|---|
|    | <p><b>Intel® Ethernet Network Adapter E810-CQDA2 for OCP 3.0</b></p> <p>iPC E810CQDA1OCPV3<br/> MM# 983092<br/> UPC 00735858461115<br/> EAN 5032037200639<br/> MOQ 1</p> <p><b>Product type</b> 1U/2U accessory kit</p>  | <ul style="list-style-type: none"> <li>• Single port, QSFP28, 100/50/25/10 GbE OCP* 3.0 Module</li> <li>• Connects to server board using Mezzanine Connector</li> <li>• Supports PCIe* x16 Gen 4.0 lanes</li> <li>• Supports Pull Tab module installation/removal mechanism</li> <li>• Concurrent RDMA (iWARP and RoCEv2) support</li> <li>• Data Plane Development Kit (DPDK) Optimized</li> <li>• Application Device Queues (ADQ) support</li> <li>• Extensive Network Virtualization Overlay protocol support</li> <li>• Enhanced QoS and Access Control List (ACL) support</li> </ul> |
|    | <p><b>Intel® Ethernet Network Adapter E810-CQDA2 for OCP 3.0</b></p> <p>iPC E810CQDA2OCPV3<br/> MM# 983581<br/> UPC 00735858456883<br/> EAN 5032037196512<br/> MOQ 1</p> <p><b>Product type</b> 1U/2U accessory kit</p>  | <ul style="list-style-type: none"> <li>• Dual port, QSFP28, 100/50/25/10 GbE OCP* 3.0 Module</li> <li>• Connects to server board using Mezzanine Connector</li> <li>• Supports PCIe* x16 Gen 4.0 lanes</li> <li>• Supports Pull Tab module installation/removal mechanism</li> <li>• Concurrent RDMA (iWARP and RoCEv2) support</li> <li>• Data Plane Development Kit (DPDK) Optimized</li> <li>• Application Device Queues (ADQ) support</li> <li>• Extensive Network Virtualization Overlay protocol support</li> <li>• Enhanced QoS and Access Control List (ACL) support</li> </ul>   |
|   | <p><b>Intel Ethernet Network Adapter E810-XXVDA2 for OCP 3.0</b></p> <p>iPC E810XXVDA2OCPV3<br/> MM# 983262<br/> UPC 00735858452977<br/> EAN 5032037193238<br/> MOQ 1</p> <p><b>Product type</b> 1U/2U accessory kit</p> | <ul style="list-style-type: none"> <li>• Dual port, SFP28, 25/10 GbE OCP* 3.0 Module</li> <li>• Connects to server board using Mezzanine Connector</li> <li>• Supports PCIe* x16 Gen 4.0 lanes</li> <li>• Concurrent RDMA (iWARP and RoCEv2) support</li> <li>• Data Plane Development Kit (DPDK) Optimized</li> <li>• Application Device Queues (ADQ) support</li> <li>• Extensive Network Virtualization Overlay protocol support</li> <li>• Enhanced QoS and Access Control List (ACL) support</li> </ul>  |
|  | <p><b>Intel Ethernet Network Adapter E810-XXVDA2 for OCP 3.0</b></p> <p>iPC E810XXVDA4OCPV3<br/> MM# 983099<br/> UPC 0735858489546<br/> EAN 5032037225786<br/> MOQ 1</p> <p><b>Product type</b> 1U/2U accessory kit</p>  | <ul style="list-style-type: none"> <li>• Quad port, SFP28, 25/10 GbE OCP* 3.0 Module</li> <li>• Connects to server board using Mezzanine Connector</li> <li>• Supports PCIe* x16 Gen 4.0 lanes</li> <li>• Concurrent RDMA (iWARP and RoCEv2) support</li> <li>• Data Plane Development Kit (DPDK) Optimized</li> <li>• Application Device Queues (ADQ) support</li> <li>• Extensive Network Virtualization Overlay protocol support</li> <li>• Enhanced QoS and Access Control List (ACL) support</li> </ul>  |

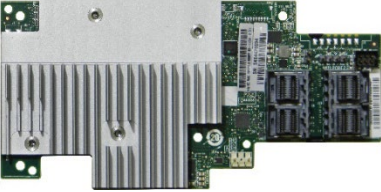
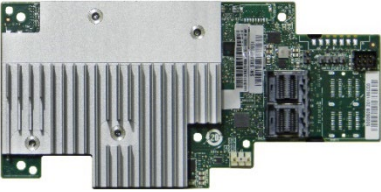
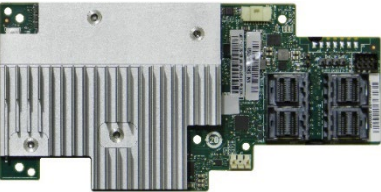
## Intel® Server M50CYP Family Configuration Guide


| Image   | Details   | Description   |
|---|---|---|
|    | <p><b>Intel® Ethernet Network Adapter X710 for OCP 3.0</b></p> <p>iPC X710DA2OCPV3<br/> MM# 979095<br/> UPC 00735858421232<br/> EAN 5032037163743<br/> MOQ 1</p> <p><b>Product type</b> 1U/2U accessory kit</p>     | <ul style="list-style-type: none"> <li>• Dual port, SFP+ DA, 2X 10 GbE OCP* 3.0 Module</li> <li>• Connects to server board using Mezzanine Connector</li> <li>• Supports PCIe* x16 Gen 3.0 lanes</li> <li>• Supports Pull Tab module installation/removal mechanism</li> <li>• Network Virtualization (VXLAN, GENEVE, NVGRE, MPLS, and VXLAN-GPE with NSH) support</li> <li>• Intel® Ethernet Flow Director support for hardware based application traffic steering</li> <li>• Data Plane Development Kit (DPDK) Optimized</li> </ul> |
|    | <p><b>Intel® Ethernet Network Adapter X710 for OCP 3.0</b></p> <p>iPC X710DA4OCPV3<br/> MM# 979098<br/> UPC 00735858421195<br/> EAN 5032037163705<br/> MOQ 1</p> <p><b>Product type</b> 1U/2U accessory kit</p>     | <ul style="list-style-type: none"> <li>• Quad port, SFP+ DA, 2X 10 GbE OCP* 3.0 Module</li> <li>• Connects to server board using Mezzanine Connector</li> <li>• Supports PCIe* x16 Gen 3.0 lanes</li> <li>• Supports Pull Tab module installation/removal mechanism</li> <li>• Network Virtualization (VXLAN, GENEVE, NVGRE, MPLS, and VXLAN-GPE with NSH) support</li> <li>• Intel® Ethernet Flow Director support for hardware based application traffic steering</li> <li>• Data Plane Development Kit (DPDK) Optimized</li> </ul> |
|   | <p><b>Intel® Ethernet Network Adapter X710-T2L for OCP 3.0</b></p> <p>iPC X710T2LOCPV3<br/> MM# 9999MJ<br/> UPC 00735858447027<br/> EAN 5032037188111<br/> MOQ 1</p> <p><b>Product type</b> 1U/2U accessory kit</p> | <ul style="list-style-type: none"> <li>• Dual port, RJ45, 10/1 GbE OCP* 3.0 Module</li> <li>• Connects to server board using Mezzanine Connector</li> <li>• Supports PCIe* x16 Gen 3.0 lanes</li> <li>• Supports Pull Tab module installation/removal mechanism</li> <li>• Network Virtualization (VXLAN, GENEVE, NVGRE, MPLS, and VXLAN-GPE with NSH) support</li> <li>• Intel® Ethernet Flow Director support for hardware based application traffic steering</li> <li>• Data Plane Development Kit (DPDK) Optimized</li> </ul>     |
|  | <p><b>Intel® Ethernet Network Adapter X710-T4L for OCP 3.0</b></p> <p>iPC X710T4LOCPV3<br/> MM# 9999ML<br/> UPC 00735858450010<br/> EAN 5032037190619<br/> MOQ 1</p> <p><b>Product type</b> 1U/2U accessory kit</p> | <ul style="list-style-type: none"> <li>• Quad port, RJ45, 10/1 GbE OCP* 3.0 Module</li> <li>• Connects to server board using Mezzanine Connector</li> <li>• Supports PCIe* x16 Gen 3.0 lanes</li> <li>• Supports Pull Tab module installation/removal mechanism</li> <li>• Network Virtualization (VXLAN, GENEVE, NVGRE, MPLS, and VXLAN-GPE with NSH) support</li> <li>• Intel® Ethernet Flow Director support for hardware based application traffic steering</li> <li>• Data Plane Development Kit (DPDK) Optimized</li> </ul>     |

## 5.3 Intel® RAID Add-In Cards, Modules, and Accessories

### 5.3.1 Intel® Integrated RAID Module RMSP3 Product Family



Table 30. Intel® Integrated RAID Module RMSP3 Product Family – SAS 3.0 (12 Gb/s)

| Image  | Details   | Description  |
|--|---|--|
|   | <p><b>Intel® Integrated Storage Module RMSP3JD160J</b></p> <p><b>iPC</b> RMSP3JD160J<br/> <b>MM#</b> 954490<br/> <b>UPC</b> 00735858329118<br/> <b>EAN</b> 5032037095235<br/> <b>MOQ</b> 5</p> <p><b>Product type</b> 1U/2U accessory kit</p> | <p>Mezzanine Form Factor Storage Module<br/>                     Entry Level SAS Storage Controller<br/>                     16 internal SAS / SATA ports (NVMe* mode not supported on M50CYP Family)<br/>                     Avago* SAS3516 IOC<br/>                     Storage Levels – JBOD (SAS/SATA Connectivity)</p> <p>SAS data cables not included and must be purchased separately.</p>   |
|   | <p><b>Intel® Integrated RAID Module RMSP3HD080E</b></p> <p><b>iPC</b> RMSP3HD080E<br/> <b>MM#</b> 954553<br/> <b>UPC</b> 00735858329125<br/> <b>EAN</b> 5032037095242<br/> <b>MOQ</b> 5</p> <p><b>Product type</b> 1U/2U accessory kit</p>    | <p>Mezzanine Form Factor RAID Module<br/>                     Entry level RAID Module<br/>                     8 internal SAS / SATA ports (NVMe* mode not supported on M50CYP Family)<br/>                     Avago* SAS3408 IOC<br/>                     RAID Levels – 0/1/10/5 and JBOD</p> <p>SAS data cables not included and must be purchased separately.</p>  |
|  | <p><b>Intel® Integrated RAID Module RMSP3AD160F</b></p> <p><b>iPC</b> RMSP3AD160F<br/> <b>MM#</b> 954552<br/> <b>UPC</b> 00735858329149<br/> <b>EAN</b> 5032037095266<br/> <b>MOQ</b> 5</p> <p><b>Product type</b> 1U/2U accessory kit</p>    | <p>Mezzanine Form Factor RAID Module<br/>                     Full Featured RAID Controller<br/>                     16 internal SAS / SATA ports (NVMe* mode not supported on M50CYP Family)<br/>                     Avago* SAS3516 ROC<br/>                     RAID Levels – 0/1/10/5/6/50/60 and JBOD<br/>                     Supports Maintenance Free Backup Unit – iPC <b>AXXRMFBU7</b><br/>                     Supports the following Intel® RAID Accessory Option:</p> <ul style="list-style-type: none"> <li>• Intel® RAID Drive Encryption Management – iPC <b>AXXRPFKDE2</b></li> </ul> <p>SAS data cables not included and must be purchased separately.</p> |

| Image   | Details  | Description   |
|---|--|---|
|  | <p><b>Intel® Integrated RAID Module RMSP3CD080F</b></p> <p><b>iPC</b> RMSP3CD080F<br/> <b>MM#</b> 954489<br/> <b>UPC</b> 00735858329132<br/> <b>EAN</b> 5032037095259<br/> <b>MOQ</b> 5</p> <p><b>Product type</b> 1U/2U accessory kit</p> | <p>Mezzanine Form Factor RAID Module<br/>                     Full Featured RAID Controller<br/>                     8 internal SAS / SATA ports (NVMe* mode not supported on M50CYP Family)<br/>                     Avago* SAS3508 ROC<br/>                     RAID Levels – 0/1/10/5/6/50/60 and JBOD<br/>                     Supports Maintenance Free Backup Unit – iPC <b>AXXRMFBU7</b><br/>                     Supports Intel® RAID Drive Encryption Management – iPC <b>AXXRPFKDE2</b></p> <p>SAS data cables not included and must be purchased separately.</p> |

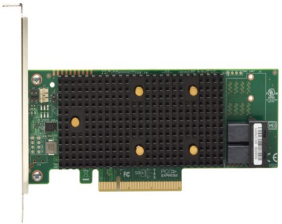
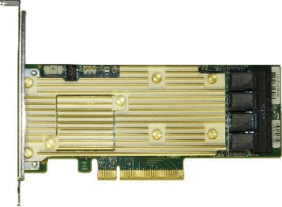

### 5.3.2 Intel® RAID Controller Add-in Cards

**Table 31. Intel® RAID Controller Add-in Cards – SAS 3.0 (12 Gb/s)**


| Image  | Details   | Description   |
|--|---|---|
|   | <p><b>Intel® Storage Controller RSP3QD160J</b></p> <p><b>iPC</b> RSP3QD160J<br/> <b>MM#</b> 954491<br/> <b>UPC</b> 00735858329101<br/> <b>EAN</b> 5032037095228<br/> <b>MOQ</b> 5</p> <p><b>Product type</b> 2U accessory kit</p> | <p>Low Profile, half length, (MD2 Compliant) PCIe* add-in card<br/>                     Entry level SAS/SATA adapter.<br/>                     16 internal SAS / SATA ports (NVMe* mode not supported on M50CYP Family)<br/>                     Avago* SAS3416 IOC<br/>                     JBOD (SAS/SATA Connectivity)</p> <p>SAS data cables not included and must be purchased separately.</p> |
|  | <p><b>Intel® Storage Controller RSP3GD016J</b></p> <p><b>iPC</b> RSP3GD016J<br/> <b>MM#</b> 954492<br/> <b>UPC</b> 00735858329156<br/> <b>EAN</b> 5032037095273<br/> <b>MOQ</b> 5</p> <p><b>Product type</b> 2U accessory kit</p> | <p>Low Profile, half length, (MD2 Compliant) PCIe* add-in card<br/>                     Entry level SAS/SATA adapter.<br/>                     16 external SAS / SATA ports (NVMe* mode not supported on M50CYP Family)<br/>                     Avago* SAS3416 IOC<br/>                     JBOD (SAS/SATA Connectivity)</p> <p>SAS data cables not included and must be purchased separately.</p> |




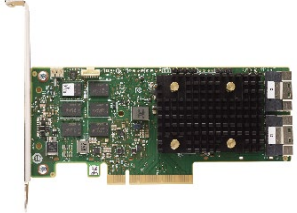
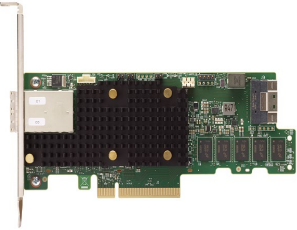
## Intel® Server M50CYP Family Configuration Guide

| Image   | Details  | Description  |
|---|--|--|
|  | <p><b>Intel® RAID Controller RSP3WD080E</b></p> <p><b>iPC</b> RSP3WD080E<br/> <b>MM#</b> 954495<br/> <b>UPC</b> 00735858329170<br/> <b>EAN</b> 5032037095297<br/> <b>MOQ</b> 5</p> <p><b>Product type</b> 2U accessory kit</p> | <p>Low Profile, half length, (MD2 Compliant) PCIe* add-in card<br/>                     Entry Level SAS/SATA RAID Controller<br/>                     8 internal SAS/SATA ports (NVMe* mode not supported on M50CYP Family)<br/>                     Avago* SAS3408 ROC<br/>                     RAID Levels – 0/1/10/5 and JBOD</p> <p>SAS data cables not included and must be purchased separately.</p>   |
|  | <p><b>Intel® RAID Controller RSP3TD160F</b></p> <p><b>iPC</b> RSP3TD160F<br/> <b>MM#</b> 954493<br/> <b>UPC</b> 00735858329163<br/> <b>EAN</b> 5032037095280<br/> <b>MOQ</b> 5</p> <p><b>Product type</b> 2U accessory kit</p> | <p>Low Profile, half length, (MD2 Compliant) PCIe* add-in card<br/>                     Full Featured SAS/SATA RAID Controller<br/>                     16 internal SAS/SATA ports (NVMe* mode not supported on M50CYP Family)<br/>                     Avago* SAS3516 ROC<br/>                     RAID Levels – 0/1/10/5/6/50/60 and JBOD<br/>                     Supports Maintenance Free Backup Unit – iPC <b>AXXRMFBU7</b></p> <p>SAS data cables not included and must be purchased separately.</p>  |
|  | <p><b>Intel® RAID Controller RSP3MD088F</b></p> <p><b>iPC</b> RSP3MD088F<br/> <b>MM#</b> 954551<br/> <b>UPC</b> 00735858329194<br/> <b>EAN</b> 5032037095310<br/> <b>MOQ</b> 5</p> <p><b>Product type</b> 2U accessory kit</p> | <p>Low Profile, half length, (MD2 Compliant) PCIe* add-in card<br/>                     Full Featured SAS/SATA RAID Controller<br/>                     8 internal SAS/SATA ports (NVMe* mode not supported on M50CYP Family)<br/>                     8 external SAS ports<br/>                     Avago* SAS3516 ROC<br/>                     RAID Levels – 0/1/10/5/6/50/60 and JBOD<br/>                     Supports Maintenance Free Backup Unit – iPC <b>AXXRMFBU7</b></p> <p>SAS data cables not included and must be purchased separately.</p> |

**Table 32. Intel® RAID Controller Add-in Cards – SAS 3.0 (12 Gb/s) and NVMe\* PCIe\* 4.0**

| Image   | Details  | Description  |
|---|--|--|
|  | <p><b>Intel® Storage Controller RS3P4QF160J</b></p> <p><b>iPC</b> RS3P4QF160J<br/> <b>MM#</b> 999RKM<br/> <b>UPC</b> 00735858452830<br/> <b>EAN</b> 5032037193115<br/> <b>MOQ</b> 5</p> <p><b>Product type</b> 1U/2U accessory kit</p> | <p>Low Profile, half length, (MD2 Compliant) PCIe* add-in card<br/>                     Entry level Tri-Mode SAS/SATA/NVMe* adapter.<br/>                     16 internal SAS / SATA ports / 4 NVMe* (PCIe* gen4)<br/>                     Broadcom* SAS3816 IOC<br/>                     JBOD (SAS/SATA/NVMe* Connectivity)</p> <p>SAS and NVMe* data cables not included and must be purchased separately.</p> |

## Intel® Server M50CYP Family Configuration Guide

| Image  | Details  | Description   |
|--|--|---|
|   | <p><b>Intel® Storage Controller RS3P4GF016J</b></p> <p><b>iPC</b> RS3P4GF016J<br/> <b>MM#</b> 999TJ3<br/> <b>UPC</b> 00735858452823<br/> <b>EAN</b> 5032037193108<br/> <b>MOQ</b> 5</p> <p><b>Product type</b> 1U/2U accessory kit</p> | <p>Low Profile, half length, (MD2 Compliant) PCIe* add-in card<br/>                     Entry level Tri-Mode SAS/SATA/NVMe* adapter.<br/>                     16 external SAS / SATA ports<br/>                     Broadcom* SAS3816 IOC<br/>                     JBOD (SAS/SATA Connectivity)</p> <p>SAS data cables not included and must be purchased separately.</p>   |
|   | <p><b>Intel® RAID Controller RS3P4TF160F</b></p> <p><b>iPC</b> RS3P4TF160F<br/> <b>MM#</b> 999TJ4<br/> <b>UPC</b> 00735858452816<br/> <b>EAN</b> 5032037193092<br/> <b>MOQ</b> 5</p> <p><b>Product type</b> 1U/2U accessory kit</p>    | <p>Low Profile, half length, (MD2 Compliant) PCIe* add-in card<br/>                     Full Featured Tri-Mode RAID Controller<br/>                     16 internal SAS / SATA ports / 4 NVMe* (PCIe* 4.0)<br/>                     Broadcom* SAS3916 ROC<br/>                     RAID Levels – 0/1/10/5/6/50/60 and JBOD<br/>                     Supports Maintenance Free Backup Unit – iPC <b>AXXRMFBU7</b></p> <p>SAS and NVMe* data cables not included and must be purchased separately.</p>  |
|  | <p><b>Intel® RAID Controller RS3P4MF088F</b></p> <p><b>iPC</b> RS3P4MF088F<br/> <b>MM#</b> 99ADDX<br/> <b>UPC</b> 00735858486590<br/> <b>EAN</b> 5032037223287<br/> <b>MOQ</b> 5</p> <p><b>Product type</b> 1U/2U accessory kit</p>    | <p>Low Profile, half length, (MD2 Compliant) PCIe* add-in card<br/>                     Full Featured Tri-Mode RAID Controller<br/>                     8 internal SAS / SATA ports / 2 NVMe* (PCIe* 4.0) (NVMe* mode not supported on M50CYP Family)<br/>                     8 external SAS<br/>                     Broadcom* SAS3916 ROC<br/>                     RAID Levels – 0/1/10/5/6/50/60 and JBOD<br/>                     Supports Maintenance Free Backup Unit – iPC <b>AXXRMFBU7</b></p> <p>SAS and NVMe* data cables not included and must be purchased separately.</p> |

### 5.3.3 Intel® VROC Keys

Three supported types of Intel® VROC Keys are shown in the following table.

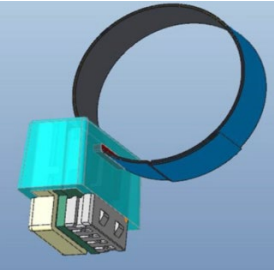
**Table 33. Optional VROC 7.5 Upgrade Key - Supported NVMe\* RAID Features**

| NVMe* RAID Major Features                              | Standard Intel®<br>VROC 7.5 Key<br>(iPC VROCSTANMOD) | Premium Intel®<br>VROC 7.5 Key<br>(iPC VROCPREMOD) | Intel® SSD Only<br>VROC 7.5 Key<br>(iPC VROCISSDMOD) |
|--|--|--|--|
| <b>Processor-attached NVMe* SSD – high performance</b> | Yes  | Yes  | Yes  |

Intel® Server M50CYP Family Configuration Guide



| NVMe* RAID Major Features                              | Standard Intel® VROC 7.5 Key (iPC VROCSTANMOD) | Premium Intel® VROC 7.5 Key (iPC VROCPREMMOD) | Intel® SSD Only VROC 7.5 Key (iPC VROCISSDMOD) |
|--|--|---|--|
| Boot on RAID volume                                    | Yes  | Yes   | Yes  |
| Third party vendor SSD support                         | Yes  | Yes   | No   |
| RAID 0/1/10  | Yes  | Yes   | Yes  |
| RAID 0/1/5/10  | No   | Yes   | Yes  |
| RAID write hole closed (RMFBU replacement)             | No   | Yes   | Yes  |
| Hot plug/ surprise removal (2.5" SSD form factor only) | Yes  | Yes   | Yes  |
| Enclosure LED management                               | Yes  | Yes   | Yes  |

Table 34. Intel® VROC Key Option

| Image  | Details   | Description   |
|--|---|---|
|   | <p><b>Standard Intel® VROC Key</b></p> <p><b>iPC</b> VROCSTANMOD<br/> <b>MM#</b> 951605<br/> <b>UPC</b> 00735858337243<br/> <b>EAN</b> 5032037100007<br/> <b>MOQ</b> 1</p> <p><b>Product type</b> 1U/2U building block/spare FRU<br/> 1U/2U accessory kit</p> | <p><b>Intel® VROC 7.5 Key for 1U/2U systems</b></p> <p><b>Kit includes:</b><br/> (1) – Standard Intel® VROC 7.5 key</p> |
|   | <p><b>Premium Intel® VROC Key</b></p> <p><b>iPC</b> VROCPREMMOD<br/> <b>MM#</b> 951606<br/> <b>UPC</b> 00735858337267<br/> <b>EAN</b> 5032037100014<br/> <b>MOQ</b> 1</p> <p><b>Product type</b> 1U/2U building block/spare FRU<br/> 1U/2U accessory kit</p>  | <p><b>Intel® VROC 7.5 Key for 1U/2U systems</b></p> <p><b>Kit includes:</b><br/> (1) – Premium Intel® VROC 7.5 key</p>  |
|  | <p><b>Intel® SSD Only VROC Key</b></p> <p><b>iPC</b> VROCISSDMOD<br/> <b>MM#</b> 956822<br/> <b>UPC</b> 00735858337274<br/> <b>EAN</b> 5032037100021<br/> <b>MOQ</b> 1</p> <p><b>Product type</b> 1U/2U building block/spare FRU<br/> 1U/2U accessory kit</p> | <p><b>Intel® VROC 7.5 Key for 1U/2U systems</b></p> <p><b>Kit includes:</b><br/> (1) – Intel® SSD Only VROC 7.5 key</p> |




5.3.4 Miscellaneous Intel® RAID Accessory Options



Table 35. Intel® RAID Accessory Options


| Image   | Details   | Description  |
|---|---|--|
|  <p>The image shows the Intel RAID Maintenance Free Backup Unit (AXXRMFBU7). It consists of a black metal housing with a circular cutout, a white super-capacitor module, and a black cable with a SATA connector and a power connector.</p> | <p><b>Intel® RAID Maintenance Free Backup Unit AXXRMFBU7</b></p> <p><b>iPC</b> AXXRMFBU7<br/> <b>MM#</b> 957677<br/> <b>UPC</b> 00735858336192<br/> <b>EAN</b> 5032037099790<br/> <b>MOQ</b> 5</p> <p><b>Product type</b> 1U/2U accessory kit</p> | <p>A super-capacitor module designed to protect data in dynamic memory during a power failure or system crash event. The AXXRMFBU7 is used with the full-featured tri-mode RAID modules and controllers.</p> <p>Compatible with:</p> <ul style="list-style-type: none"> <li>• Intel® Integrated RAID Module RMSP3AD160F</li> <li>• Intel® Integrated RAID Module RMSP3CD080F</li> <li>• Intel® RAID Controller RSP3TD160F</li> <li>• Intel® RAID Controller RSP3DD080F</li> <li>• Intel® RAID Controller RSP3MD088F</li> <li>• Intel® RAID Controller RS3P4TF160F</li> <li>• Intel® RAID Controller RS3P4MF088F</li> </ul> |
|  <p>The image shows the Intel RAID Drive Encryption Management key. It is a green printed circuit board (PCB) with a black key component and a small black component labeled 'U1' and 'J1'.</p>  | <p><b>Intel® RAID Drive Encryption Management</b></p> <p><b>iPC</b> AXXRPFKDE2<br/> <b>MM#</b> 915317<br/> <b>UPC</b> 00735858221474<br/> <b>EAN</b> 5032037051705<br/> <b>MOQ</b> 5</p> <p><b>Product type</b> 1U/2U accessory kit</p>           | <p>Upgrade key to enable drive encryption management for Intel® RAID Controllers RSP3TD160F, RSP3MD088F, RMSP3AD160F, RMSP3CD080F</p>  |

## 5.4 Power Supply Unit Options and Power Cable Kits

**Table 36. Power Supply Modules and Power Cords**

| Image   | Details  | Description   |
|---|--|---|
|    | <p><b>2100 W AC Common Redundant Power Supply</b></p> <p><b>iPC</b> FCXX2100CRPS<br/> <b>MM#</b> 999D4L<br/> <b>UPC</b> 00735858424592<br/> <b>EAN</b> 5032037166829<br/> <b>MOQ</b> 1</p> <p><b>Product type</b> 2U building<br/> block/spare FRU<br/> 2U accessory kit</p>       | <p>2100 W AC common redundant power supply with 80 PLUS* Platinum efficiency. Power cord sold separately.</p> |
|    | <p><b>1600 W AC Common Redundant Power Supply</b></p> <p><b>iPC</b> AXX1600TCRPS<br/> <b>MM#</b> 99ADF2<br/> <b>UPC</b> 00735858407038<br/> <b>EAN</b> 5032037151245<br/> <b>MOQ</b> 1</p> <p><b>Product type</b> 1U/2U building<br/> block/spare FRU<br/> 1U/2U accessory kit</p> | <p>1600 W AC common redundant power supply with 80 PLUS* Titanium efficiency. Power cord sold separately.</p> |
|  | <p><b>1300 W AC Common Redundant Power Supply</b></p> <p><b>iPC</b> AXX1300TCRPS<br/> <b>MM#</b> 956542<br/> <b>UPC</b> 00735858345705<br/> <b>EAN</b> 5032037106191<br/> <b>MOQ</b> 1</p> <p><b>Product type</b> 1U/2U building<br/> block/spare FRU<br/> 1U/2U accessory kit</p> | <p>1300 W AC common redundant power supply with 80 PLUS* Titanium efficiency. Power cord sold separately.</p> |

| Image   | Details   | Description   |
|---|---|---|
|  | <p><b>1500 mm (59 in) North America power cable</b></p> <p><b>iPC</b> FPWRCABLENA<br/> <b>MM#</b> 879287<br/> <b>UPC</b> 00735858181129<br/> <b>EAN</b> 5032037015738<br/> <b>MOQ</b> 1</p> <p><b>Product type</b> 1U/2U spare FRU<br/> 1U/2U accessory kit</p> | <p>1500 mm (59 in) North America power cable</p>  |
|  | <p><b>Kit to support 2 internal SATA SSDs</b></p> <p><b>iPC</b> CYPCBLINTSTKIT<br/> <b>MM#</b> 99A5A1<br/> <b>UPC</b> 00735858471619<br/> <b>EAN</b> 5032037210058<br/> <b>MOQ</b> 1</p> <p><b>Product type</b> 1U accessory kit</p>                            | <p>Power cable for internal SATA SSDs, Mini SAS HD to 7-pin SATA, internal SATA SSD bracket. Used in 2U systems as spare and/or accessory (M50CYP2UR208 based x8, x16, x24 front drive bay systems, M50CYP2UR312)</p> <p><b>Kit Includes:</b></p> <ul style="list-style-type: none"> <li>• (1) – <b>120/180 mm</b> splitter cable, 2U Power cable for internal SATA. Power cable connects server board 3.3/5/12 V power connector to internal SATA SSD power connectors.</li> <li>• (1) – <b>175 mm</b> cable, server board Mini SAS HD connectors to internal 7-pin SATA SSD (2 ports) (RA to VT)</li> <li>• (1) – Sheet metal bracket for internal SATA SSDs</li> </ul> |

| Image   | Details  | Description   |
|---|--|---|
|  | <p><b>iPC</b><br/> <b>MM#</b><br/> <b>UPC</b><br/> <b>EAN</b><br/> <b>MOQ</b></p> <p>CYPCBLCOMMKIT<br/>           99A3P1<br/>           00735858475266<br/>           5032037213219<br/>           1</p> | <p>Low cost cable kit. Used in 1U / 2U systems as spare or accessory.</p> <p><b>Kit Includes:</b></p> <ul style="list-style-type: none"> <li>• (1) – <b>455/565/720 mm</b> splitter cable, 2U Power cable, server board to HSBPs (1, 2, and 3) (2x6 pin to three 2x2 pin)</li> <li>• (1) – <b>445/720 mm</b> splitter cable, 1U/2U Power cable, server board to HSBP (2x3 pin to two 2x2 pin)</li> <li>• (1) – <b>425/660 mm</b> splitter cable, 2U Power cable, server board to 3.5"HSBP (2x6 pin to two 2x2 pin)</li> <li>• (1) – <b>125/355 mm</b> splitter cable, 1U/2U Power cable, server board to Midplane card / SAS Interposer card (2x2 pin to two 2x2 pin)</li> <li>• (1) – <b>598.5 mm</b> cable, Front control panel cable for 2U systems (26 pin)</li> <li>• (1) – <b>597.5 mm</b> cable, Front control panel cable for 1U systems (26 pin)</li> <li>• (1) – <b>601 mm</b> cable, USB 3.0/2.0 cable for front USB panel (26 pin) for 2U and 1U systems</li> <li>• (1) – <b>75 mm</b> cable, HSBP I<sup>2</sup>C connector to midplane card I<sup>2</sup>C connector (5 pin to 5 pin)</li> <li>• (1) – <b>250 mm</b> cable, server board I<sup>2</sup>C connector (Left of board) to HSBP (Left) I<sup>2</sup>C connector (5 Pin to 5 Pin)</li> <li>• (1) – <b>350 mm</b> cable, server board I<sup>2</sup>C connector (Left) to HSBP I<sup>2</sup>C connector (Middle) (5 pin to 5 pin)</li> <li>• (1) – <b>610 mm</b> cable, server board I<sup>2</sup>C connector (rear) to SAS Interposer card I<sup>2</sup>C connector (10 pin to 10 pin)</li> <li>• (1) – <b>900 mm</b> cable, server board to Front control panel / USB panel (26 pin to 26 pin)</li> <li>• (1) – <b>180 mm</b> cable, server board I<sup>2</sup>C connector to Midplane card I<sup>2</sup>C connector (5 pin to 5 pin)</li> <li>• (1) – <b>90 mm</b> cable, HSBP3 I<sup>2</sup>C connector (right) to Midplane card I<sup>2</sup>C connector (5 pin to 3 pin)</li> <li>• (1) – <b>75 mm</b> cable, I<sup>2</sup>C Jumper Cable (connects Midplane cards) (3 pin to 3 pin)</li> </ul> |





## 5.5 1U / 2U Rack Mount Kits

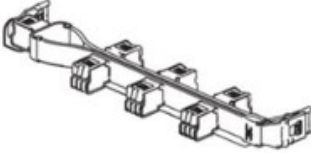


**Advisory Note:** Available rack and cabinet mounting kits are not designed to support shipment of the server system while installed in a rack. If you choose to do so, Intel advises verification of your shipping configuration with appropriate shock and vibration testing before shipment. Intel does not perform shipping tests that cover the complex combination of unique rack offerings and custom packaging options.

**Caution:** Exceeding the specified maximum weight limit of a given rail kit or misalignment of the server in the rack may result in failure of the rack rails, damaging the system or causing personal injury. Using two people or the use of a mechanical assist tool to install and align the server into the rack is highly recommended.

**Caution:** Exceeding the rail kit's specified maximum weight limit or misalignment of the server in the rack may result in failure of the rack rails. This situation could damage the system or cause personal injury. Using two people or the use of a mechanical assist tool to install and align the server into the rack is highly recommended.

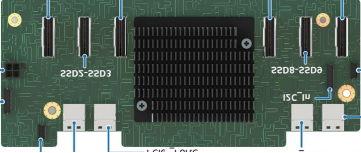
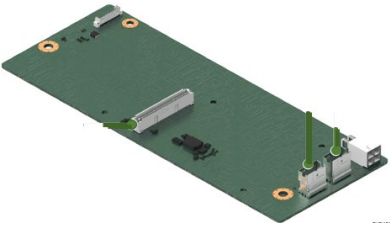
**Table 37. Rack Mount Kits**



| Image   | Details   | Description   |
|---|---|---|
|    | <p><b>1U/2U Full Extension Rail Kit</b></p> <p><b>iPC</b> CYPFULLEXTRAIL<br/> <b>MM#</b> 999ZCN<br/> <b>UPC</b> 00735858447096<br/> <b>EAN</b> 5032037188180<br/> <b>MOQ</b> 1</p> <p><b>Product type</b> 2U accessory kit</p>    | <p><b>CYPFULLEXTRAIL</b> – Premium Rail Kit with cable management arm (CMA) support</p> <ul style="list-style-type: none"> <li>• 1U, 2U compatible</li> <li>• Tool-less installation</li> <li>• Rack installation front and rear post distance adjustment from 623 mm ~ 942 mm</li> <li>• 820 mm travel distance</li> <li>• Full extension from rack</li> <li>• 31 Kgs (68.34 lbs.) maximum supported weight</li> <li>• Support for Cable Management Arm AXXCMA2</li> </ul>   |
|  | <p><b>1U/2U Half Extension Rail Kit</b></p> <p><b>iPC</b> CYPHALFEXTRAIL<br/> <b>MM#</b> 99A3RR<br/> <b>UPC</b> 00735858456333<br/> <b>EAN</b> 5032037196017<br/> <b>MOQ</b> 1</p> <p><b>Product type</b> 1U/2U accessory kit</p> | <p><b>CYPHALFEXTRAIL</b> –Value Rack Mount Rail Kit</p> <ul style="list-style-type: none"> <li>• 1U, 2U compatible</li> <li>• Tool-less chassis attachment</li> <li>• Tools required to attach rails to rack</li> <li>• Rack installation front and rear post distance adjustment from 660 mm to 838 mm</li> <li>• 560 mm travel distance</li> <li>• Half extension from rack</li> <li>• Support for front cover removal and fan replacement</li> <li>• 31 kg (68.34 lbs.) maximum support weight</li> </ul> <p><b>Note:</b> No cable management arm support.</p> |


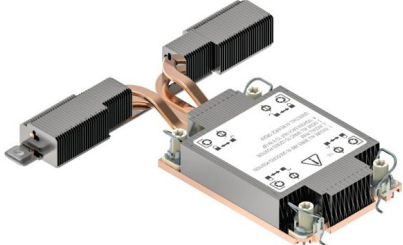
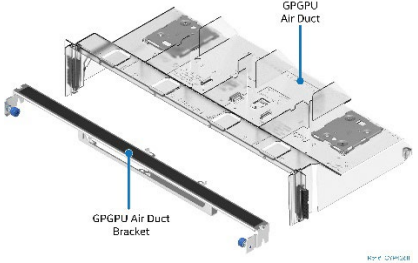
| Image   | Details   | Description  |
|---|---|--|
|  | <p><b>AXXCMA2 – Cable Management Arm</b></p> <p><b>iPC</b> AXXCMA2<br/> <b>MM#</b> 939211<br/> <b>UPC</b> 00735858292009<br/> <b>EAN</b> 5032037070560<br/> <b>MOQ</b> 1</p> <p><b>Product type</b> 1U/2U accessory kit</p> | <p>Supports CYPFULLEXTRAIL only</p>  |
|  | <p><b>2U Bezel Kit</b></p> <p><b>iPC</b> CYP2UBEZEL<br/> <b>MM#</b> 99A5T7<br/> <b>UPC</b> 00735858471657<br/> <b>EAN</b> 5032037210096<br/> <b>MOQ</b> 1</p> <p><b>Product type</b> 2U accessory kit</p>                   | <p>Bezel Kit for M50CYP2UR based systems.</p> <p><b>Kit Includes:</b><br/> (1) – 2U Bezel.</p> |
|  | <p><b>1U Bezel Kit</b></p> <p><b>iPC</b> MYP1UBEZEL<br/> <b>MM#</b> 99A2D7<br/> <b>UPC</b> 00735858455244<br/> <b>EAN</b> 5032037195164<br/> <b>MOQ</b> 1</p> <p><b>Product type</b> 1U accessory kit</p>                   | <p>Bezel Kit for M50CYP1UR based systems.</p> <p><b>Kit Includes:</b><br/> (1) – 1U Bezel.</p> |

## 6. 1U / 2U Miscellaneous Accessory Options

Table 38. Miscellaneous Accessory Options

| Image  | Details  | Description  |
|--|--|--|
|   | <p><b>PCIe Midplane Card</b></p> <p><b>iPC</b> CYP SWITCHMP<br/> <b>MM#</b> 99A3PJ<br/> <b>UPC</b> 00735858471824<br/> <b>EAN</b> 5032037210263<br/> <b>MOQ</b> 1</p> <p><b>Product type</b> 2U accessory kit</p>      | <p>This kit provides additional NVMe front drive bay support for system configurations having more than eight NVMe drives.</p> <p><b>Kit Includes:</b></p> <ul style="list-style-type: none"> <li>(1) – Midplane card</li> <li>(1) – <b>125/355 mm</b> power cable, server board to Midplane cards (2x2 pin to two 2x2 pin)</li> <li>(1) – <b>75 mm</b> cable, Midplane card (Left) I<sup>2</sup>C connector to Midplane card (Right) I<sup>2</sup>C connector (5 pin to 5 pin)</li> <li>(1) – <b>180 mm</b> cable, server board I<sup>2</sup>C connector to Midplane card (Right) I<sup>2</sup>C connector (5 pin to 5 pin)</li> <li>(1) – <b>90 mm</b> cable, HSBP3 (right) I<sup>2</sup>C connector to Midplane card (Right) I<sup>2</sup>C connector (5 pin to 3 pin)</li> <li>(1) – <b>75 mm</b> cable, connects Midplane card (Left) I<sup>2</sup>C Jumper to Midplane card (Right) I<sup>2</sup>C Jumper (3 pin to 3 pin)</li> </ul> <p><b>Required (sold separately):</b> PCIe Midplane card data cable kit iPC <b>CYPCBLSLMIDPIN</b> and iPC <b>CYPCBLSLMIDPOUT</b>. See <a href="#">Table 25</a></p> |
|  | <p><b>SAS Interposer Card</b></p> <p><b>iPC</b> CYP SASMODINT<br/> <b>MM#</b> 99A3PX<br/> <b>UPC</b> 00735858471831<br/> <b>EAN</b> 5032037210270<br/> <b>MOQ</b> 1</p> <p><b>Product type</b> 1U/2U accessory kit</p> | <p>This kit provides additional SAS/SATA front drive bay support for system configurations having more than eight SAS/SATA drives.</p> <p><b>Kit Includes:</b></p> <ul style="list-style-type: none"> <li>(1) – SAS Interposer card</li> </ul>   |

| Image  | Details  | Description   |
|--|--|---|
|   | <p><b>SAS Expander Card</b></p> <p><b>iPC</b> RES3TV360<br/> <b>MM#</b> 932894<br/> <b>UPC</b> 00735858287364<br/> <b>EAN</b> 5032037067102<br/> <b>MOQ</b> 5</p> <p><b>Product type</b> 2U accessory kit</p>  | <p>This kit provides additional SAS/SATA front drive bay support for system configurations having more than 16 SAS/SATA drives. This card is supported only if connected to a SAS/SATA ROC module.</p> <p><b>SAS Expander Card Features:</b></p> <ul style="list-style-type: none"> <li>• SAS 3.0 12 Gb/s Expander card featuring 6 Gbps data aggregation for 12 Gbps data transfer with 6 Gb/s devices</li> <li>• Internal mount midplane form factor</li> <li>• 36 internal ports supporting point-to-point 12, 6, and 3 Gb/s data transfer rates</li> <li>• 4-pin right angle power connector</li> <li>• Mini-SAS HD 8643 connectors</li> </ul> <p><b>Each Kit Includes:</b></p> <ul style="list-style-type: none"> <li>(1) – SAS expander card</li> <li>(1) – <b>130 mm</b> power cable</li> <li>(4) – <b>165 mm</b> cable, Expander card HD to HSBP HD</li> <li>(1) – <b>300 mm</b> cable, Expander card HD- to HSBP HD</li> <li>(1) – <b>250 mm</b> cable, Expander card HD to BP HD</li> <li>(3) – rubber pads mounting screws</li> </ul> <p><b>Required (sold separately):</b> SAS data cable kit iPC <b>CYPCBLHDHDXXX1</b> – Expander to backplane. See <a href="#">Table 22</a></p> <hr/> <p><b>Note:</b> The onboard SATA ports are not compatible with SAS expander cards. The onboard SATA ports can only be cabled directly to a specified backplane.</p> |
|  | <p><b>2U Tall Heat Sink</b></p> <p><b>iPC</b> CYP2UHSSTD<br/> <b>MM#</b> 99A3RL<br/> <b>UPC</b> 00735858475259<br/> <b>EAN</b> 5032037213202<br/> <b>MOQ</b> 1</p> <p><b>Product type</b> 2U accessory kit</p> | <p>Spare 2U tall heat sink</p> <hr/> <p><b>Note:</b> Systems installed with 2U standard heat sink(s) only support half-length add-in cards</p> <hr/> <p><b>Includes:</b></p> <ul style="list-style-type: none"> <li>(1) – 2U tall heat sink</li> </ul>  |

| Image  | Details   | Description   |
|--|---|---|
|   | <p><b>1U Tall Heat Sink</b></p> <p><b>iPC</b> CYP1UHSSTD<br/> <b>MM#</b> 99A3NP<br/> <b>UPC</b> 00735858454735<br/> <b>EAN</b> 5032037194679<br/> <b>MOQ</b> 1</p> <p><b>Product type</b> 1U/2U accessory kit</p> | <p>Spare 1U tall heat sink</p> <p><b>Includes:</b></p> <p>(1) – 1U tall heat sink</p>   |
|   | <p><b>1U EVAC Heat Sink</b></p> <p><b>iPC</b> CYP1UHSEVAC<br/> <b>MM#</b> 99A3NV<br/> <b>UPC</b> 00735858471862<br/> <b>EAN</b> 5032037210300<br/> <b>MOQ</b> 1</p> <p><b>Product type</b> 1U accessory kit</p>   | <p>Spare EVAC heat sink</p> <hr/> <p><b>Note:</b> Only supported in M50CYP2UR204 systems, 1U x4 systems.</p> <hr/> <p><b>Kit includes:</b></p> <p>(1) – EVAC heat sink</p>  |
|  | <p><b>2U GPGPU Air Duct</b></p> <p><b>iPC</b> CYPGPGPUKIT<br/> <b>MM#</b> 99A3RD<br/> <b>UPC</b> 00735858471626<br/> <b>EAN</b> 5032037210065<br/> <b>MOQ</b> 1</p> <p><b>Product type</b> 2U spare FRU</p>       | <p>Required 2U accessory kit when installing GPGPU accelerator add-in cards.</p> <p><b>Kit includes:</b></p> <p>(1) – GPGPU air duct<br/> (1) – GPGPU air duct bracket<br/> (2) – <b>200/250 mm</b> GPGPU power cable<br/> (2) – <b>235 mm</b> ATS300W power cable<br/> (2) – Intel® RAID Maintenance Free Backup Unit (RMFBU) bracket</p> <hr/> <p><b>Note:</b> The Intel® Server System M50CYP1UR and M50CYP2UR families do not support GPGPU accelerator cards with active heat sinks.</p> <p><b>Note:</b> Systems configured with any type of GPGPU card must have the shipping bracket installed before the system is exposed to any level of shock or vibration or is shipped to the end user location. Failure to install the shipping bracket can cause serious damage to various components within the system.</p> <hr/> |

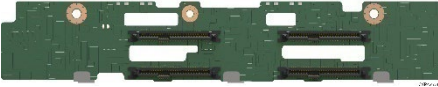

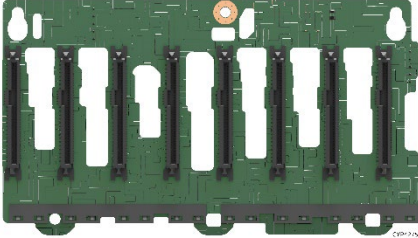
Intel® Server M50CYP Family Configuration Guide


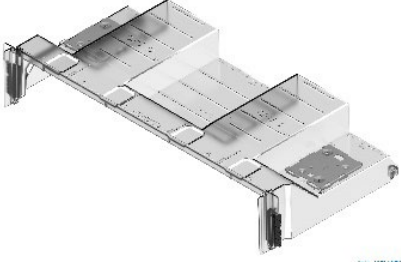
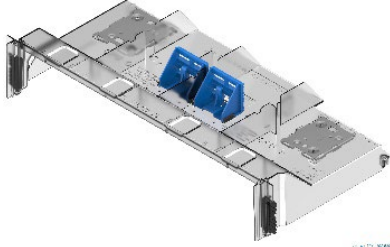

| Image | Details  | Description  |
|-------|--|--|
|       | <p><b>Advanced System Management Key</b></p> <p><b>iPC</b>            ADVSYSTEMGMTKEY<br/> <b>MM#</b>            99AJX5<br/> <b>UPC</b>            N/A<br/> <b>EAN</b>            N/A<br/> <b>MOQ</b>            1</p> <p><b>Product type</b>    1U/2U accessory</p> | <p>Software electronic key to be uploaded to the BMC</p> <hr/> <p><b>Note:</b> Needed to enable advance system management features on Integrated BMC Web Console. For more information, see the <i>Intel® Server Board M50CYP2SB Family Technical Product Specification</i>.</p> <hr/> |

## 7. 1U / 2U Spare and Replacement Parts (FRUs)

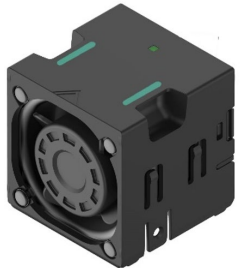


System integrators and distributors may choose to hold additional stock of individual system components. Intel makes available the following spare and replacement parts (FRUs) compatible with the specified Intel® server family.

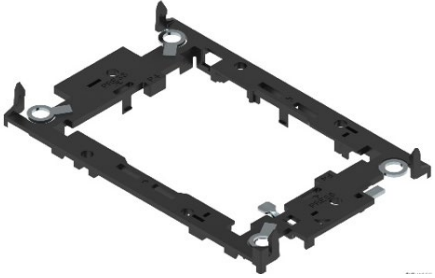


**Table 39. Spare and Replacement Parts**

| Image   | Details   | Description  |
|---|---|--|
|    | <p><b>1U 4 x 2.5" Spare Hot Swap Backplane</b></p> <p><b>iPC</b> CYPHSBP1204<br/> <b>MM#</b> 99A3NM<br/> <b>UPC</b> 00735858471800<br/> <b>EAN</b> 5032037210249<br/> <b>MOQ</b> 1</p> <p><b>Product type</b> 1U spare FRU</p>          | <p>Hot-swap backplane board spare supporting SAS/SATA and NVMe* drives in the M50CYP1UR204 system.</p> <p><b>Kit Includes:</b><br/> (1) – Backplane board.</p>   |
|    | <p><b>1U 12 x 2.5" SAS/SATA/NVMe Hot Swap Backplane</b></p> <p><b>iPC</b> CYPHSBP1212<br/> <b>MM#</b> 99A3NN<br/> <b>UPC</b> 00735858471817<br/> <b>EAN</b> 5032037210256<br/> <b>MOQ</b> 1</p> <p><b>Product type</b> 1U spare FRU</p> | <p>Hot-swap backplane board spare supporting SAS/SATA and NVMe* drives in the M50CYP1UR212 system.</p> <p><b>Kit Includes:</b><br/> (1) – Backplane board.</p>   |
|  | <p><b>2U 8 x 2.5" Hot Swap Backplane</b></p> <p><b>iPC</b> CYPHSBP2208<br/> <b>MM#</b> 99A3NF<br/> <b>UPC</b> 00735858471787<br/> <b>EAN</b> 5032037210225<br/> <b>MOQ</b> 1</p> <p><b>Product type</b> 2U spare FRU</p>                | <p>Hot-swap backplane board spare supporting SAS/SATA and NVMe* drives in the M50CYP2UR208-based systems.</p> <p><b>Kit Includes:</b><br/> (1) – Backplane board.<br/> (1) – <b>75 mm</b> cable, HSBP I<sup>2</sup>C connector to HSBP I<sup>2</sup>C connector (5 pin to 5 pin)<br/> (1) – <b>250 mm</b> cable, server board I<sup>2</sup>C connector (Left) to HSBP I<sup>2</sup>C connector (Left) (5 pin to 5 pin)<br/> (1) – <b>350 mm</b> cable, server board I<sup>2</sup>C connector (Left) to HSBP (Middle) I<sup>2</sup>C connector (5 pin to 5 pin)</p> |

| Image   | Details  | Description  |
|---|--|--|
|    | <p><b>12 x 3.5" SAS/SATA/NVMe Hot Swap Backplane</b></p> <p><b>iPC</b> CYPHSBP2312<br/> <b>MM#</b> 99A3NL<br/> <b>UPC</b> 00735858471794<br/> <b>EAN</b> 5032037210232<br/> <b>MOQ</b> 1</p> <p><b>Product type</b> 2U spare FRU</p> | <p>Combination hot-swap backplane board spare supporting SAS and NVMe* drives in the M50CYP2UR312 systems.</p> <p><b>Kit Includes:</b><br/>                     (1) – Backplane board.</p>   |
|    | <p><b>2U Tall Air Duct</b></p> <p><b>iPC</b> BRPDUCTSTD<br/> <b>MM#</b> 99A3NW<br/> <b>UPC</b> 00735858471633<br/> <b>EAN</b> 5032037210072<br/> <b>MOQ</b> 1</p> <p><b>Product Type</b> 2U spare FRU</p>                            | <p>Air duct for 2U-Tall heat sink</p> <p><b>Kit Includes:</b><br/>                     (1) – Air duct with holders for add-in cards.<br/>                     (2) – Intel® RAID Maintenance Free Backup Unit (RMFBU) bracket installed on top of air duct.</p>             |
|   | <p><b>1U Tall Air Duct</b></p> <p><b>iPC</b> BRPDUCTSWFHFL<br/> <b>MM#</b> 99A3RP<br/> <b>UPC</b> 00735858471640<br/> <b>EAN</b> 5032037210089<br/> <b>MOQ</b> 1</p> <p><b>Product type</b> 2U spare FRU</p>                         | <p>Air duct for 1U-Tall heat sink</p> <p><b>Kit Includes:</b><br/>                     (1) – Air duct with holders for full length add-in cards.<br/>                     (2) – Intel® RAID Maintenance Free Backup Unit (RMFBU) bracket installed on top of air duct.</p> |
|  | <p><b>1U System Fan</b></p> <p><b>iPC</b> CYPFAN1UKIT<br/> <b>MM#</b> 99A3NZ<br/> <b>UPC</b> 00735858471848<br/> <b>EAN</b> 5032037210287<br/> <b>MOQ</b> 4</p> <p><b>Product type</b> 1U spare FRU</p>                              | <p>Spare system fans</p> <p><b>Each Kit Includes:</b><br/>                     (1) – 40 x 40 x 38 mm dual motor system fans with 8-pin connectors.</p>   |



| Image  | Details  | Description  |
|--|--|--|
|   | <p><b>2U Fan</b></p> <p><b>iPC</b> CYPFAN2UKIT<br/> <b>MM#</b> 99A3P0<br/> <b>UPC</b> 00735858471855<br/> <b>EAN</b> 5032037210294<br/> <b>MOQ</b> 3</p> <p><b>Product type</b> 2U spare FRU</p>   | <p><b>Each Kit Includes:</b></p> <p>(1) – 60 x 60 x 38 mm dual motor system fans with 6-pin connectors.</p>  |
|  | <p><b>2.5" SSD Drive Mounting Rail Plus Drive Extraction Lever Kit</b></p> <p><b>iPC</b> CYP25HSCARRIER<br/> <b>MM#</b> 99AKCJ<br/> <b>UPC</b> 00735858471596<br/> <b>EAN</b> 5032037210034<br/> <b>MOQ</b> 1</p> <p><b>Product type</b> 1U/2U spare FRU</p> | <p>Spare 2.5" SSD Drive Mounting Rail Plus Drive</p> <p><b>Each Kit Includes:</b></p> <p>(8) –2.5" SSD drive mounting rails plus drive extraction lever<br/>             (8) –2.5" SSD drive blank</p> |
|                        | <p><b>3.5" Tool Less Hot Swap Drive Carrier</b></p> <p><b>iPC</b> FXX35HSCAR2<br/> <b>MM#</b> 958245<br/> <b>UPC</b> 00735858345675<br/> <b>EAN</b> 5032037106160<br/> <b>MOQ</b> 1</p> <p><b>Product type</b> 1U/2U spare FRU</p>                           | <p>Spare 3.5" tool less drive hot swap drive carrier</p> <p><b>Includes:</b></p> <p>(1) – 3.5" tool less drive hot swap drive carrier with mounting screws for mounting 2.5" SSDs.</p>                 |

| Image  | Details   | Description  |
|--|---|--|
|   | <p><b>Processor Carrier Clip</b></p> <p><b>iPC</b> ICXPHMMOQ2<br/> <b>MM#</b> 99A3PL<br/> <b>UPC</b> 00735858475273<br/> <b>EAN</b> 5032037213226<br/> <b>MOQ</b> 2</p> <p><b>Product type</b> 1U/2U spare FRU</p>                        | <p>Spare processor carrier clip</p> <p><b>Kit Includes:</b><br/>                     (2) – processor carrier clip</p>  |
|   | <p><b>Trusted Platform Module (TPM) 2.0</b></p> <p><b>iPC</b> AXXTPMENC8<br/> <b>MM#</b> 955867<br/> <b>UPC</b> 00735858345712<br/> <b>EAN</b> 5032037106207<br/> <b>MOQ</b> 1</p> <p><b>Product type</b> 1U/2U accessory kit</p>         | <p>A TPM is a hardware-based security device that addresses the growing concern on boot process integrity and offers better data protection. TPM protects the system start-up process by ensuring it is tamper-free before releasing system control to the operating system. A TPM device provides secured storage to store data, such as security keys and passwords. In addition, a TPM device has encryption and hash functions.</p> <p>AXXTPMENC8 implements TPM as per TPM PC Client specifications revision 2.0 by the Trusted Computing Group (TCG)</p>   |
|  | <p><b>Intel® Trusted Platform Module (TPM) 2.0</b></p> <p><b>iPC</b> AXXTPMCHNE8<br/> <b>MM#</b> 960608<br/> <b>UPC</b> 00735858347341<br/> <b>EAN</b> 5032037107068<br/> <b>MOQ</b> 1</p> <p><b>Product type</b> 1U/2U accessory kit</p> | <hr/> <p><b>Note:</b> AXXTPMCHNE8 compatible for use in China.</p> <hr/> <p>A TPM is a hardware-based security device that addresses the growing concern on boot process integrity and offers better data protection. TPM protects the system start-up process by ensuring it is tamper-free before releasing system control to the operating system. A TPM device provides secured storage to store data, such as security keys and passwords. In addition, a TPM device has encryption and hash functions.</p> <p>AXXTPMCHNE8 implements TPM as per TPM PC Client specifications revision 2.0 by the Trusted Computing Group (TCG)</p> |

## Appendix A. Glossary

| Term                      | Definition  |
|---------------------------|---|
| <b>BIK</b>                | Baseboard In Knock-Down-Kit – Integrated System   |
| <b>CMA</b>                | Cable Management Arm  |
| <b>CRPS</b>               | Common Redundant Power Supply   |
| <b>DDDC</b>               | Double Device Data Correction   |
| <b>EAN</b>                | International Article Number (Barcode)  |
| <b>ECC</b>                | Error Correcting Code   |
| <b>EMI</b>                | Electromagnetic Interference  |
| <b>FRU</b>                | Field Replaceable Unit  |
| <b>GPGPU</b>              | General Purpose computing on Graphics Processing Unit   |
| <b>iPC</b>                | Intel Product Code  |
| <b>iPN</b>                | Intel Product Number  |
| <b>JBOD</b>               | Just a bunch of drives  |
| <b>L6 BIK</b>             | Integrated system with no processors, memory, or storage devices installed                                |
| <b>L9 BIK</b>             | Integrated system including storage devices, but no processors or memory                                  |
| <b>KDK</b>                | Knock-Down-Kit – (Chassis only product)   |
| <b>KVM</b>                | Keyboard, Video, Mouse  |
| <b>MM#</b>                | Master Material order number  |
| <b>MOQ</b>                | Minimum Order Quantity  |
| <b>NVMe*</b>              | NVM Express* – based on Non-Volatile Memory Host Controller Interface Specification (NVMHCI)              |
| <b>ODD</b>                | Optical disk drive  |
| <b>Intel® OP HFI</b>      | Intel® Omni-Path Host Fabric Interface  |
| <b>Optional Accessory</b> | Hardware that can be added to the system to enhance the default feature set of the shipping configuration |
| <b>PCBA</b>               | Printed Circuit Board Assembly  |
| <b>QSFP</b>               | Quad Small Form Factor Pluggable  |
| <b>RAID</b>               | Redundant Array of Independent Drives   |
| <b>Required Option</b>    | Hardware that must be added to the shipping configuration for the system to operate                       |
| <b>RMFBU</b>              | RAID Maintenance Free Backup Unit   |
| <b>ROC</b>                | RAID on Chip  |
| <b>RA</b>                 | Right Angle cable connector position  |
| <b>RRA</b>                | Reverse Right Angle cable connector position  |
| <b>SAS</b>                | Serial Attached SCSI  |

## Intel® Server M50CYP Family Configuration Guide

| Term               | Definition   |
|--------------------|--|
| <b>SATA</b>        | Serial ATA   |
| <b>SFF NVMe*</b>   | NVMe SSD in a 2.5" form factor                                   |
| <b>SFF</b>         | Small Form Factor  |
| <b>SFP</b>         | Small Form factor Pluggable                                      |
| <b>SKU</b>         | Stock Keeping Unit   |
| <b>SSD</b>         | Solid State Drive  |
| <b>TPM</b>         | Trusted Platform Manager   |
| <b>UPC</b>         | Universal Product Code (Barcode)                                 |
| <b>VT</b>          | Vertical connector position (also known as horizontal, straight) |
| <b>Intel® VCA</b>  | Intel® Visual Compute Accelerator                                |
| <b>Intel® VROC</b> | Intel® Virtual RAID on CPU                                       |
| <b>PCN</b>         | Product Change Notification                                      |